

TMR The Main Resource

TECHNICIANS CHOICE

Automotive Professional Products





Deborah Bjorklund
President, CEO



TMR is based on the principle of "THE CUSTOMER"
"The Customer is not only the *Company* you sell, but the
Vendor that provides and the
Staff that makes it all Happen



Dona Boozer
Sales Specialist
16 Years



Jaser Rivera
International Sales
2 Years



Don Tinker
Sales Specialist
7 Years



Mary Goodell
Sales Specialist
17 Years



Janet Graham
Sales Specialist
17 Years



7135 16th Street East, Suite 124

Sarasota, Florida 34243

941-351-7751 | 800-888-7751

Fax 941-351-3987 | 888-351-3987

www.themainresource.com | sales@themainresource.com

TABLE OF CONTENTS

<u>ABRASIVES</u>	47-48
<u>AIR CONDITIONING</u>	41
<u>ALIGNMENT</u>	20
<u>ASSORTMENTS</u>	37-38
<u>BRAKE LATHE ACCESSORIES</u>	14-19
<u>BRAKE COILS, LINES & FITTINGS</u>	42
<u>DRAIN PLUGS - GASKETS</u>	39
<u>ELECTRICAL</u>	43-44
<u>FITTINGS AND HOSE CLAMPS</u>	35
<u>FUEL FILTERS - REPAIR KITS</u>	40
<u>LIFT PADS</u>	21
<u>RIVETS - RETAINERS</u>	36
<u>SHOP SUPPLIES</u>	45-46
<u>SOCKETS AND TORQUE STICKS</u>	33
<u>TIRE CHANGER ACCESSORIES</u>	1-7
<u>TIRE REPAIR</u>	29-30
<u>TIRE REPAIR TOOLS</u>	28
<u>TIRE VALVES</u>	31-32
<u>TPMS</u>	22-27
<u>WATER SEPARATORS</u>	20
<u>WHEEL BALANCER ACCESSORIES</u>	8-13
<u>WHEEL NUTS AND STUDS</u>	34

TIRE CHANGER

Mount / Demount Heads

TC0343-6	Nylon Mount And Demount Head (6 Pack)					
	O.E.M.	Part Number	Tire Changer			
	Accuturn	SM102529	220A, All Other Models Require 102765 Adapter			
	Hunter	RP6 0343B	TC250 • TC300 • TC325 • TC350			
			TC2000 • TC3250 • TC3500			
	Ranger		TC3000 And TC 3100 Series (Require Adapter) Most Models Except R980A, R980E (Some Require Adapters)			
TCR343	RED Nylon Mount And Demount Head (Each)					
TCR343-6	RED Nylon Mount And Demount Head (6 Pack)					
	O.E.M.	Part Number	Tire Changer			
	Hunter	221-675-2	TC 250 • TC 300 • TC325			
		221-675-2-B	TC250 • TC300 • TC325 • TC350			
			TC2000 • TC3250 • TC3500 TC3000 And TC 3100 Series (Require Adapter)			
TC183061	Nylon Mount / Demount Head Kit With Tapered Hole					
	Use With Tapered Shaft 182767 Or 182812.					
	O.E.M.	Part Number	Tire Changer			
	Coats	8183061	5030 • 5040 • 5050 • 5060 • 5065			
			6050 • 6060 • 6065 • 7050 • 7055			
			7060 • 7065 • 7655 • 7660 • 7665			
TC182960	Coats	8182960				
	Ranger	5150524	For R980A And R980E (Requires 5150523 Mounting Flange)			
TC184432	Low Profile Grey Nylon Mount / Demount Head Kit - For Use With Low Profile Tires					
	O.E.M.	Part Number	Tire Changer			
	Coats	8184432	5030 • 5040 • 5050 • 5060 • 5065			
			6050 • 6060 • 6065 • 7050 • 7055			
			7060 • 7065 • 7655 • 7660 • 7665			
TC250309	Nylon Mount / Demount Head Kit With Round Hole					
	Not For Use On Hofmann 1550, 1620 And 1625.					
	O.E.M.	Part Number	Tire Changer			
	All Tool	G2008401	All Models			
	Coats	82008402	RC 1 • 5 • 10 • 15 • 20 • Early 5060			
			9010 • 9024 • APX90			
	Corghi	250309	All Rim Clamp (Optional Accessory)			
	Hofmann	2200981	All Earlier Models Except 1550 • 1620 • 1625			
	Sice	2200981	M39, S40, S41, S42, S43, S45, S408MAXI, S435, S436, S436TC			
TC450310	Nylon Mount / Demount Head With Round Hole <i>Head Only</i>					
	For TC 250309 Mount / Demount Head Kit.					
	O.E.M.	Part Number	Tire Changer			
	All Tool	G3008403	All Models			
	Coats	83008403	RC 1 • 5 • 10 • 15 • 20 • Early 5060			
			9010 • 9024 • APX90			
	Corghi	450310	All Rim Clamp (Optional Accessory)			
	Giuliano	3008403	Shaft Needs To Be Turned 180 Degrees For This Head To Work			
	Hofmann	8314813	All Earlier Models Except 1550 • 1620 • 1625			
	Hunter	RP11-8314813	Fits All TCX Series			
			(Earlier TCX500 Requires Upgrade Shaft And Adapter Kit RP11-8-114-00091)			
	Sice	8314813	M39, S40, S41, S42, S43, S45, S408MAXI, S435, S436, S436TOP			
TC14024784	Nylon Mount/Demount Head Kit					
	O.E.M.	Part Number	Tire Changer			
	Accuturn	14024784	3602 • 3602HP • 4260 • 4560MR • 4602 • 5602 • 5602 HP			
	Hofmann	4024784	1520 • 1565 • 1620 • 1625 • 1625EM • 3300 • 3300EM			
		Monty	1270, 2300, 3000, 3000GP			
	John Bean	EAA 0247G20A	EHP System IVE • IV • III • IIE			
	Snap On	EAA 0247G20A	All Models			
TC20024335	Nylon Mount/Demount Head For TC 14024784 Mount / Demount Head Kit. <i>Head Only</i>					
	O.E.M.	Part Number	Tire Changer			
	Accuturn	20024335	3602 • 3602HP • 4260 • 4560MR • 4602 • 5602 • 5602 HP			
	Hofmann	24335	1520 • 1565 • 1620 • 1625 • 1625EM • 3300 • 3300EM			
			Monty 1270, 2300, 3000, 3000GP			
	John Bean	24335	EHP System IVE • IV • III • IIE			
	Snap On	24335	All Models			

TIRE CHANGER

Stainless Steel Mount / Demount Heads And Inserts

TC182788 **Stainless Steel Mount / Demount Head With Tapered Hole For Coats**
O.E.M. **Part Number** **Tire Changer**
 Coats 8182788 5030 • 5040 • 5050 • 5060 • 5065 • 5070
 6050 • 6060 • 6065 • 7050 • 7055
 7060 • 7065 • 7655 • 7660 • 7665



TC183429 **Stainless Steel Mount / Demount Head With Round Hole**
O.E.M. **Part Number** **Tire Changer**
 Coats 8183429 RC 1 • 5 • 10 • 15 • 20, Early 5060
 Corghi 258458 All Models



TI182961 (2 Pk) **Plastic Insert For TC182788 And TC183429 Stainless Steel Mount/Demount Heads**
TI182963 (12 Pk) **O.E.M.** **Part Number** **Tire Changer**
 Coats 8182961 (2Pk) RC 1 • 5 • 10 • 15 • 20 • Early 5060
 8182963 (12Pk) 5030 • 5040 • 5050 • 5060 • 5065 • 5070
 6050 • 6060 • 6065 • 7050 • 7055
 7060 • 7065 • 7655 • 7660 • 7665



TC101608 **Plastic Insert For Sicam Tire Changer (5 Pk)**
O.E.M. **Part Number** **Tire Changer**
 Sicam SM101608 Accuturn, Bosch, Sicam



TI254341A **Plastic Inserts For Mount And Demount Head (10 Pk) Includes Allen Wrench**
O.E.M. **Part Number** **Tire Changer**
 Coats 89209611 RC 1 • 5 • 10 • 20 • 9010 • 9024
 Corghi 254341A 2024 • 9220 • 9824



TI20011064 **Plastic Inserts For Mount And Demount Head (Bulk - Bulk Does Not Include Pin)**
O.E.M. **Part Number** **Tire Changer**
TC24016079 (4 Pk) Accuturn 20011064 3402 • 3450 • 3602 • 4602
TC2001106410 (10 Pk) Accuturn 24016079 5802HP • 5850HP • 5602



TI4096-10 **Hunter Nose Inserts From TI11400096 Kit For Steel Mount Heads (10 Pk)**
O.E.M. **Part Number** **Tire Changer**
 Hunter Hunter TCX Series



TI4636-10 **Hunter Back Inserts From TI11400096 Kit For Steel Mount Heads (10 Pk)**
O.E.M. **Part Number** **Tire Changer**
 Hunter Hunter TCX Series



TI11400096 **Insert Kit For Hunter Steel Mounthead (10 Pcs Each Of TI4096 And TI4636)**
O.E.M. **Part Number** **Tire Changer**
 Hunter RP11-8-11400096 TCX Series



TC247G15A-10 **Plastic Long Inserts For Stainless Mount And Demount Head (10 Pk)**
O.E.M. **Part Number** **Tire Changer**
 Hofmann ST4024181 All Models
 Snap-On EAA0247G15A All Models



Jaws • Clamping Kits

TC181677-4 **Rim Clamp Jaw For Coats Tire Changer**
O.E.M. **Part Number** **Tire Changer**
 Coats 818677 R1, 5, 10, 15, 20



TC182247-4 **2 Position Clamping Jaws For Coats X-Models With Adjustable Carriers.**
 6" To 20" Range
O.E.M. **Part Number** **Tire Changer**
 Coats 81822474 50X • 60X • 70X
 (ONLY Works With Upgraded Carriage System)



TC113125C **3 Position Extended X-Clamp Kit For Coats X-Models With Adjustable**
TC8184926 **Kit Includes:** Carriers. External (Outside / In) Wheel Clamping 6" - 22" Wheels
 TC 182250 Position Push Buttons (4 Pcs)
 TC 184126 3 Position X-Clamp (4 Pcs)
O.E.M. **Part Number** **Tire Changer**
 Coats 8113125C 50X • 60X • 70X
 (ONLY Works With Upgraded Carriage System)
 (Does Not Work With 5030, 5040, 5045: Must Use TC182247)



TIRE CHANGER

Jaws • Clamping Kits cont.

TC184327 **24" X-Out Clamp Kit** For Clamping 23" And 24" Alloy Wheels.
13" - 24" Range. 2 Position Clamps. Outside Clamping Only.

Kit Includes:

TC 184268 24" X-Out Clamps (4 Pcs)
TC 182250 Position Push Buttons (4 Pcs)
TC 183604 Quilted Clamp Socks (10 Pcs)

O.E.M. **Part Number**
Coats 8184327

Tire Changer
50X • 60X • 70X
(ONLY Works With Upgraded Carriage System)



TC184958-4 **28" Extension Jaw** For Coats Tire Changers

O.E.M. **Part Number** **Tire Changer**
Coats 818948 50X, 60X, 70X



TC182250 **Spring Loaded Position Push Buttons**
For 2 And 3 Button Jaws



TC183604 **Quilted Clamp Sock** For Jaws And Coats Rim Clamp Tire Changers (10 Pack)

O.E.M. **Part Number** **Tire Changer**
Coats 8183604 All Tire Changers (Except 9010 And 9024E)



TCB304 **Jaw/Clamp Cover** For Snap-On Clamps

O.E.M. **Part Number** **Tire Changer**
Snap-On EAA0304G21A All Models



TCB7591 **Plastic Inserts** For Snap-On Clamps

O.E.M. **Part Number** **Tire Changer**
Snap-On ST4027591 All Models



Bead Lift And Combo Tools

CT768 **Combo Tool** Specifically Designed To Mount And Demount Tire
Use With TI 30 Demount And TI 55 Mount Booties



TI30 **Large White Demount Bootie Protector**
For Demount End Of CT768/TC66679 Combo Tool



TI55 **Small White Mount Bootie Protector**
For Mount End Of CT768/TC66679 Combo Tool



TC70200 **Mag Tool** Includes Extra Set Of TC70201 Plastic Inserts



TC70201 **Mag Tool Inserts Kit**
Kit Includes 1 Each: TC70202 Nose Insert
and TC70204 Hook Insert



TCB7900 **Nylon Protective Cover** For Snap-On
O.E.M. **Part Number** **Tire Changer**
Snap-On EAA0304G15A All Models
John Bean EPH Systems, I, II, III, IV, V,
 8931, 8936, 8950, 8960,
 8990, 8991
Hofmann 3300, 3300Em, 1520, 1565, 1625EM



TC2795 **Motorcycle Tire Lever (7 3/4" Long)**



TC181354 **20 Bead Lifting Tool**
For All Rim Clamp Tire Changers



TC2402 **24" Bead Lifting Tool**
For All Rim Clamp Tire Changers



TC2505 **Bead Lift "Wave" Tool Bar**
Specially Shaped For Difficult Tire Beads

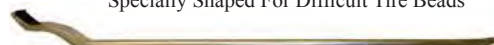

TC183605 **Bead Lift Tool Sock**
For TC181354 Bead Lift Tool (10 Pack)



TC11400098-4 (4 Pk) Long Sock
TC11400098 (Each) For TC181354 Bead Lifting Tool



TIRE CHANGER

Switches

- SW421523 Forward Reverse Switch, 40 Amp**
For Corgi, Coats RC1, 5, 10, 15 Tire Changers
- SW182958 Forward Reverse Switch, 40 Amp**
For Corgi, Coats RC1, 5, 10, 15, 20, 5000, 6000, And 7000 Series Tire Changers
(Slight Modification Needed For The RC Machines)
- SW184389 Premium Forward Reverse Switch, 25 Amp**
For Coats 5000, 6000 And 7000 Series Tire Changers
- SW20016433 Reversing On/Off Single Phase Switch Assembly; 40 Amp**
For FMC, Sanp-On, Hofmann, GS Boxer



Beadkeepers

The Beadkeeper Simply Locks Onto The Flange Of The Flange Of The Wheel And Holds The Tire Bead In Place To Eliminate Standing On The Tire And/OR Chasing The Bead Around The Wheel.

TC640
Beadkeeper
Made Of Drop-Forged



TC641C
Rubber Head Beadkeeper
Coated To Protect
Aluminum Wheels



TC642P
Beadkeepers Sold As A Pair
Connected By A Nylon Rope
Made Of Drop-Forged Steel



TC435685
Bead Depressor
Drop Center Tool



Hold Down Cones

- | | | | |
|-----------------|-----------------------|--------------------|----------------------|
| TC108276 | Hold Down Cone | | |
| | O.E.M. | Part Number | Tire Changer |
| | Coats | 8108276 | 4040 • 4040SA • 4050 |
| | | 8000433 | 4040 • 4040SA • 4050 |
| | Monty | | 2700 |
| | Snap-On | | 7600, 7600EXP, 7700 |



Tire Spreaders And Accessories

- | | | | |
|--------------|-----------------------------|--------------------------|-------------------------|
| TS989 | Manual Tire Spreader | Spread Action 1/2" To 9" | |
| | O.E.M. | Part Number | Tire Changer |
| | Coats | 8000347 | 310 • 510 • 1010 • 2020 |
-
- | | | | |
|-----------------|---------------------------------|-------------------------------------|-----------------------|
| TS108028 | Adjustable Tire Spreader | Adjustable Spread Action From 0-10" | |
| | O.E.M. | Part Number | Tire Changer |
| | Coats | 8108028 | 4040 • 4050 Rim Clamp |
-
- | | | | |
|-----------------|--|---------------------------------|-----------------------|
| TS181329 | Rim Clamp Tire Spreader Adapter | Base For TS108028 Tire Spreader | |
| | O.E.M. | Part Number | Tire Changer |
| | Coats | 8181329 | 4040 • 4050 Rim Clamp |



- TI976 Tire Service LED Work Light**
- Designed For Hands-Free Lighting During Tire Service and Other Work Applications
 - 12" Adjustable Spring-Tube For Optimum Light Positioning Within Tight Spaces
 - Clamp-On Handle Quickly And Easily "Grips" Over The Bead Of A Tire For Complete Hands-Free Light Assistance



WL98063 Work Lamp For Tire Spreaders



TIRE CHANGER

Inflator And Hose Reel

- TI508 Flexilla® Air Hose 3/8" x 50', 1/4" NPT
- TI562 Flexilla® Air Hose 3/8" x 25', 1/4" NPT
- TI584 Flexilla® Air Hose 1/4" x 50', 1/4" NPT



- Zero Memory Allowing It To Lay Flat
- Kink Resistant Under Pressure
- 300 psi Maximum Pressure
- All Weather Flexibility (-40° to 150° F)



- TI538 3/8" x 50' Hose Reel
(3/8" NPT-Inlet x 1/4" NPT Outlet)
- TI512 1/2" x 50' Hose Reel
(3/8" NPT-Inlet x 3/8" NPT Outlet)
- TI514 1/4" x 50' Hose Reel
(1/4" NPT-Inlet x 1/4" NPT Outlet)



- TI528 3/8" x 25' Reinforced Air Hose
325 PSI
- TI588 3/8" x 50' Reinforced Air Hose
325 PSI



- TI805 Lever Type Air Blow Gun
With Rubber Tip



- TI6400 Inflator Gauge (10 to 120 PSI)
12" Hose With Dual Foot Chuck



Air Gauges And Lens Cover

- LC107517 Lens Cover With Gasket For Air Gauges
O.E.M. Part Number
Coats 8107517



- AG66170 Air Gauge For FMC/John Bean Tire Changers
O.E.M. Part Number Tire Changer
FMC/John Bean 66170 7600 • 8800
Hofmann 66170 All Models



- AG107518 Air Gauge For Coats Old Style Tire Changers
Bolts On Back With Clips
O.E.M. Part Number Tire Changer
Coats 8107518 1010 • 2020 • 2020A



- AG107985 Air Gauge For Coats Tire Changers Flange Mount
O.E.M. Part Number Tire Changer
Coats 8107985 4040 • 4040A •
4040SA • 4050A



Euro Chucks

- EC2000 Heavy Duty Open End Female Style Standard Chuck
With 1/4" Steel Female Fitting
O.E.M. Part Number
Hunter 145-341-2



- EC6000C Heavy Duty Closed Female Style Standard Chuck
With 1/4" Steel Female Fitting

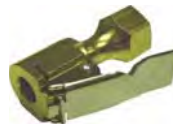

- EC410419 Open End Barbed Style European Air Chuck
Serrated Shank For 1/4" I.D. Hose
O.E.M. Part Number
Coats 841419
Hunter 145-341-2
Sice 4205451



TIRE CHANGER

Inflator Hose Assemblies

HA67715	Inflator Hose Assembly With Open End Barbed Style Euro Chuck - 52" Long All Brass Connectors (1/4" I.D. - 19 BSP) Hose Includes Euro Chuck O.E.M. Part Number FMC/John Bean 67715
HA106871	Inflator Hose Assembly With Open End Barbed Style Euro Chuck - 60" Long All Brass Connectors (1/4" I.D. - 19 BSP) Hose Includes Euro Chuck O.E.M. Part Number Coats 106871
HA137862	Inflator Hose Assembly With Open End Female Style Euro Chuck- 60" Long Male Brass Connectors (1/4" I.D. - 19 BSP) Hose Includes Euro Chuck O.E.M. Part Number Hunter 137-86-2
HA714100	Inflator Hose Assembly With Open End Barbed Style Euro Chuck - 60" Long O.E.M. Part Number Corghi 714100 Hofmann 2407055
HA2408318	Inflator Hose Assembly With Open End Barbed Style Euro Chuck - 60" Long O.E.M. Part Number Hofmann 2408318



Rubber And Nylon Pads

TC0066	Rubber Pad For Hunter Tire Changers O.E.M. Part Number Hunter RP6-0066
TI1851855	Large Pad Kit For Coats Tire Changers Kit Includes: 2 -TI181851 and 1 - TI181855
TI181065	Center Rubber Pad For Coats Tire Changers O.E.M. Part Number Coats 181065
TI181173	Small Bead Loosener Nylon Front Pad For Coats Tire Changers O.E.M. Part Number Coats 181173
TI181851	Large Bead Loosener Nylon Front Pad For Coats Tire Changers O.E.M. Part Number Coats 181851
TI181855	Large Center Rubber Pad For Coats Tire Changers O.E.M. Part Number Coats 181855



TIRE CHANGER

Tire Lube Supplies

TI35 **Long Tire Swab (14 1/2")** Used To Lubricate Tire Beads When Removing Or Mounting Tires On Rims. Extra Long For Truck Tires
O.E.M. **Part Number**
 Coats 8120366



TI50 **Standard Short Tire Swab (11 1/2")** Used To Lubricate Tire Beads When Removing Or Mounting Tires On Rims.
O.E.M. **Part Number**
 Coats 8000491
 Hunter 221-570-2
 Snap-On EAA0247C74A



TI1506 **Angled Applicator Brush**
 Handle Length 7 3/4", Brush Length 1 3/4"
O.E.M. **Part Number**
 Hunter RP6-1506



TI6350 **Truck Tire Paste Brush**
 Handle Length 10", Brush Length 1 3/4"
 Brush Head Diameter 1 3/4"



TI311 **White Euro Paste, White - 11 lb Bucket - Use With TI1625 Bracket**
 4 Per Case



TI365 **White Euro Paste, White - 6 1/2 lb Bucket - Use With TI1510 Bracket**
 4 Per Case

TI1510 **Small Paste Bucket Bracket, 6 3/4" Diameter For 7.5 to 8 lbs Standard Paste Bucket**



TI1625 **Large Paste Bucket Bracket, 8" Diameter For WIDE MOUTH Paste Bucket**

TI2600-2 **Liqui-Gel Tire Slick Bead Lube (Gallon)**



TI2650 **Comfort Grip Handle Assembly.** Use With TI2650
 Includes: TI 2625 Handle And TI 2610 Swab



LB106259 **Lube Bucket For Tire Changers (Straight)**
O.E.M. **Part Number** **Tire Changer**
 Coats 8106259 RC 15 • 20 • 5060 • 5070



LB106572 **Lube Bucket For Tire Changers (Angled)**
O.E.M. **Part Number** **Tire Changer**
 Coats 8106572 4040 • 4040SA • 4050



LB66006 **Lube Bucket For Tire Changers (Straight)**
O.E.M. **Part Number**
 Accuturn 0014466
 FMC / John Bean 66006
 Hunter 116-35-2





Haweke Flange Plate Kit

WB4220-28 28mm Kit
 WB4029-40 40mm Kit

28mm Kit Includes: 40mm Kit Includes:

- | | | |
|-------------|-------------|---|
| WB241605-28 | WB241605-40 | Flange Plate A - 4 Lug And 8 Lug Plate |
| WB251703-28 | WB251703-40 | Flange Plate B - 5 Lug Plate |
| WB251704-28 | WB251704-40 | Flange Plate C - 5 Lug Plate |
| WB261501-28 | WB261501-40 | Flange Plate D - 6 Lug Plate |
| WB271804118 | WB271804118 | Short Taper Stud - Stud II
24.5mm Head Diameter, 80mm Long (8 Pcs) |
| WB271904119 | WB271904119 | Long Taper Stud - Stud III
24.5mm Head Diameter, 90mm Long (5 Pcs) |
| WB271994121 | WB271994121 | SUV/Light Truck Stud - Stud V
22.5mm Head Diameter, 100mm Long (8 Pcs) |

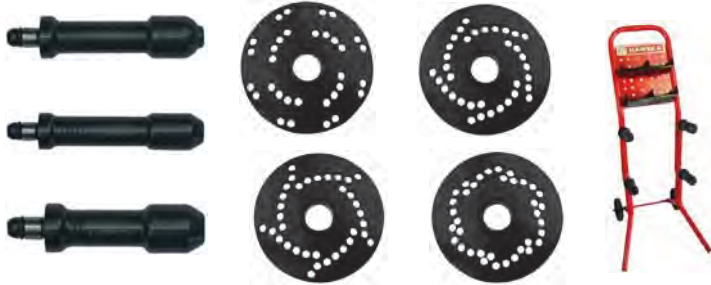

Haweke 40mm Quick Plate Set

No More Looking For Correct Bolt Pattern,
 Plates Adjust And Lock To Correct Position

WB200456405 **Haweke 40mm Quick Plate Set**
 Fully Adjustable Bolt Circle From 95 To 182mm
 (3.57" - 7.16") For All 4, 5 And 6 Hole Rims
 Kit Includes 3 Quick Plates And 1 Wallboard

- Kit Includes:**
- WB249009400 Quick Plate For 4 Lug Bolt Patterns
 - WB259009400 Quick Plate For 5 Lug Bolt Patterns
 - WB269009400 Quick Plate For 6 Lug Bolt Patterns
 - WB273008002 24.5mm / 70mm Short Taper Tips (6 Pcs)
 - WB273008003 24.5mm / 80mm Short Taper Tips (6 Pcs)
 - WB273008006 24.5mm / 80mm Ball Seat Tips (6 Pcs)
 - WB273008011 22.5mm / 90mm Long Taper Tips (6 Pcs)



Specialty Cones And Collets For Clad Wheels

WB150400110-40 **Haweke 9 Collet Kit. (40mm)**
 WB150280110-28 **Haweke 9 Collet Kit. (28mm)**
 *Clad Wheel Solution From 2" To 4.8"
 *Complete Range From 52.5mm - 122mm
 *No Interference From Cone In The Wheel Hub



- Kit Includes:**
- Cone 1 - 52.5 - 61.0mm Range
 - Cone 2 - 61.5 - 70.0mm Range
 - Cone 3 - 67.5 - 76.0mm Range
 - Cone 4 - 75.0 - 83.0mm Range
 - Cone 5 - 82.0 - 90.5mm Range
 - Cone 6 - 89.0 - 97.5mm Range
 - Cone 7 - 94.0 - 103.0mm Range
 - Cone 8 - 101.0 - 111.0mm Range
 - Cone 9 - 110.0 - 122.0mm Range

WB794-28 **28mm High Taper Cone For Current Clad Wheels**
 Can Replace Coats # 8112420
 (Will Not Work With Hunter Road Force Balancers)



WB794-40 **40mm High Taper Cone For Current Clad Wheels**
 Can Replace Coats # 8112421
 (Will Not Work With Hunter Road Force Balancers)

WB7730-28 **28mm Double Sided Collet For Clad Wheels (Jeep/Dodge/Chrysler)**
 66.5mm - 67.5mm / 71mm - 72mm



WB7730-40 **40mm Double Sided Collet For Clad Wheels (Jeep/Dodge/Chrysler)**
 66.5mm - 67.5mm / 71mm - 72mm

WB7745-28 **28mm Double Sided Collet For Clad Wheels (Dodge/Chrysler)**
 73.6mm - 74.6mm / 77mm - 78.5mm



WB7745-40 **40mm Double Sided Collet For Clad Wheels (Dodge/Chrysler)**
 73.6mm - 74.6mm / 77mm - 78.5mm

WB7755-28 **28mm Double Sided Collet For F-150 Standard Wheels and KIA/Hyundai Clad Wheels** **F150 Clad Wheels Should Be Introduced By End 2011
 86.4mm - 87.3mm / 91mm - 96mm



WB7755-40 **40mm Double Sided Collet For F-150 Standard Wheels and KIA/Hyundai Clad Wheels** **F150 Clad Wheels Should Be Introduced By End 2011
 86.4mm - 87.3mm / 91mm - 96mm

WB7764-28 **28mm Double Sided Collet For Toyota / Lexus**
 99mm - 101.5mm / 105mm - 110.7mm



WB7764-40 **40mm Double Sided Collet For Toyota / Lexus**
 99mm - 101.5mm / 105mm - 110.7mm

WHEEL BALANCER

28mm

Accuturn	5100, 5223, 5500, 5600 (Serial #51-0001 To 51-0622)
Coats	700, 800, 825, 850, 925, 950, 1000, 1025, 1050 And 1250 IBS2000 (Shaft Must Be Verified) And 6200HS
Mondolfo Ferro	All Models Excluding Truck Balancers
Norton	All Models
Snap-On	Shafts Must Be Verified
Sun	1742 And 1762

36mm

Accuturn	100, 6600, 6700 And 6800
Ammco	1030
CEMB	All Models Prior To 1995 Excluding Truck Balancers
COSENG Atlas	C301, C311, C322 And C366
Focus	All Models Excluding Truck Balancers
Launch	402 And 412
Phoenix	CB-114
Ranger	DST1000 - Check Shaft Size, Some Models Are 38mm
RAV	All Models
Rels	R1500
Werther	All Models Excluding Truck Balancers

38mm

Corghi	All Models Prior To 2007(Excluding Truck Balancers)
FAIP	All Models (Excluding Truck Balancers)

40mm

Accuturn	1200, 1220, 1250, 1400, 1420, 1450, 1500, 1520, 1550, 1650, 1820, 1850 (5100, 5323, 5500, 5600 With Serial #'s 51-0623 To 51-1457)
Bear	80-100, 80-303
Beisbarth	All Models
Bosch	All Models
CEMB	All Models 1995 And Later, (Excluding Truck Models)
Coats	(Previously Upgraded to 40mm Shafts) 700, 800, 825, 850, 925, 950, 1000, 1025, 1050, 1055, 1250 IBS 2000 (Shaft Must Be Verified), 1750, 1800, 1850, 775, 875, 1175, 6275HS, XR Balances

Corghi	All Models 2007 And Later
FMC	All Models
Hofmann	All Models
Hunter	All Models
John Bean	All Models
Kwikway	All Models
Launch	408, 500
Snap-On	Shaft Must Be Verified
Sicam	All Models

Wheel Balancer Cones

WB700-28	1.70 - 2.25 Range: 28mm
WB705-28 • 36 • 38 • 40	1.75 - 2.58 Range
WB710-28	2.25 - 2.62 Range: 28mm
WB715-28 • 36 • 38 • 40	2.44 - 3.06 Range
WB717-28 • 36 • 38 • 40	2.62 - 3.00 Range
WB718-28 • 36 • 38 • 40	3.00 - 3.25 Range
WB720-28 • 36 • 38 • 40	2.95 - 3.63 Range
WB725-28 • 36 • 38 • 40	3.375 - 5.25 Range
WB730-28 • 36 • 38 • 40	3.375 - 5.88 Range
WB735-28 • 36 • 38 • 40	5.03 - 6.88 Range
WB740-28 • 36 • 38 • 40	5.875 - 7.315 Range
WB750-28 • 36 • 38 • 40	Spacer / Backing Plate



Wheel Balancer Cone Kits

WB803-28	28mm 3 Cone System
WB804-28	28mm 4 Cone System
WB805-28 • 36 • 38 • 40	1.75 - 2.58 Range
WB810-28	2.25 - 2.62 Range
WB815-28 • 36 • 38 • 40	2.44 - 3.06 Range
WB820-28 • 36 • 38 • 40	2.95 - 3.65 Range
WB825-28 • 36 • 38 • 40	3.37 - 5.25 Range
WB830-28 • 36 • 38 • 40	3.37 - 5.88 Range
WB835-28 • 36 • 38 • 40	5.03 - 6.88 Range
WB840-28 • 36 • 38 • 40	5.875 - 7.315 Range (WB840 Does 19.5" Wheels)

Wheel Balancer Truck Cones

WB7016-28	28mm Wheel Balancer Cone (6 7/8" - 8 1/8")
WB7016-40	40mm Wheel Balancer Cone (6 7/8" - 8 1/8")
WB7015-28	28mm Wheel Balancer Spacer Backing Plate (8 3/4")
WB7015-40	40mm Wheel Balancer Spacer Backing Plate (8 3/4")



Low Profile Taper Cone Set

WB2000-28	28mm Low Profile Taper Cone Set Replaces Hunter 20-1626-1
WB2000-40	40mm Low Profile Taper Cone Set Replaces Hunter 20-1626-1



Set Includes:

WB2251-40	Range 1.69" - 2.23"
WB2252-40	Range 2.15" - 2.58"
WB2253-40	Range 2.50" - 2.94"
WB2254-40	Range 2.85" - 3.28"
WB2255-40	Range 3.20" - 3.63"
WB2256-40	Range 3.45" - 4.36"
WB2257-40	Range 4.24" - 5.18"

WHEEL BALANCER

Low And Medium Taper In-Between Cones

WB2000-40 40mm Low Profile Taper Cone Set - Replaces Hunter 20-1626-1
 WB2000-28 28mm Low Profile Taper Cone Set

REPLACES HUNTER 20-1626-1

Set Includes:
 WB2251-40 Range 1.69" - 2.23"
 WB2252-40 Range 2.15" - 2.58"
 WB2253-40 Range 2.50" - 2.94"
 WB2254-40 Range 2.85" - 3.28"
 WB2255-40 Range 3.20" - 3.63"
 WB2256-40 Range 3.45" - 4.36"
 WB2257-40 Range 4.24" - 5.18"



WB785-28 28mm Medium Taper **In-Between** Cone (74mm - 111.5mm)
 Cone is designed to fit in between the standard cones.
[TACOMA specific cone](#)



WB785-40 40mm Medium Taper **In-Between** Cone (74mm - 111.5mm)
 Cone is designed to fit in between the standard cones.
[TACOMA specific cone](#)

WB781-28 28mm Medium Taper **In-Between** Cone (44mm - 80mm)
 Cone is designed to fit in between the standard cones.
[OPTIONAL - Used for older vehicles](#)



WB781-40 40mm Medium Taper **In-Between** Cone (44mm - 80mm)
 Cone is designed to fit in between the standard cones.
[OPTIONAL - Used for older vehicles](#)

Truck Cones

WB150400091 Dual Sided Truck Cone Kit (4.72" to 6.85") With A Spacer Disk



WB7015-28 28mm Wheel Balancer Spacer Backing Plate (8 3/4")

WB7015-40 40mm Wheel Balancer Spacer Backing Plate (8 3/4")



WB7016-28 28mm Wheel Balancer Cone (6 7/8" - 8 1/8")

WB7016-40 40mm Wheel Balancer Cone (6 7/8" - 8 1/8")



WB700400201 Semi Truck / Bus Kits - For All 40mm Truck Wheel Balancers
Kit Includes:

- Heavy Duty 4 Arm Star
- Heavy Duty 5 Arm Star
- (5) Studs for Steel Wheels
- (5) Studs for Aluminum Wheels
- Basic Truck Adapter II
- Stud Piloted Wheel Centering Disc
- Hub Piloted Wheel Centering Disc

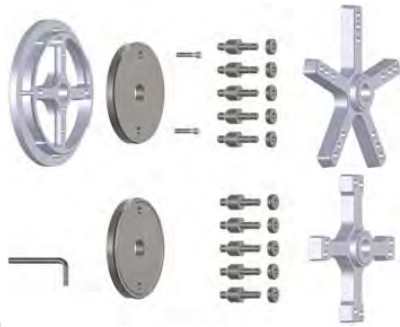

Basic Vehicle Coverage Wheel Balancer Adapter

WB114335 28mm Kit
 WB705-28
 WB715-28
 WB720-28
 WB725-28
 WB309011
 TI33
 HN110543
 WB110542
 WB790
 WB113167C

WB114339 40mm Kit
 WB705-40
 WB715-40
 WB720-40
 WB725-40
 WB309011
 TI33
 HN112103
 WB112106
 WB790-40
 WB113082

Wheel Balancer Cone 1.70 - 2.25
 Wheel Balancer Cone 2.44 - 3.06
 Wheel Balancer Cone 2.95 - 3.63
 Wheel Balancer Cone 3.375 - 5.25
 Wheel Caliper
 Premium Wheel Weight Hammer
 Manual Hub Nut
 Small Pressure Cup For Hub Nut
 Wheel Balancer Spring
 Wheel Balancer Stub Shaft



WHEEL BALANCER

Haweka

WB440

Haweka 40mm / 4mm Pitch Program Nut Kit.

- Includes:
- Quick Nut
- Clamping Hood
- Rubber Sleeve
- Pressure Ring



WB777

Wheel Balancer Shaft Gauge
Shaft & Thread Pitch



MEASURE TWICE, ORDER ONCE
"CHECK THAT THREAD PITCH"

Haweka ProGrip With Turning Handles Quick Release Nut

WB283006

28mm / 3mm Pitch

WB383006

38mm / 3mm Pitch

WB285006

28mm / 3.5mm Pitch

WB403006

40mm / 3mm Pitch

WB363006

36mm / 3mm Pitch

WB404006

40mm / 4mm Pitch



Haweka ProGrip Quick Release Nut

WB283003

28mm / 3mm Pitch

WB403003

40mm / 3mm Pitch

WB363003

36mm / 3mm Pitch

WB404003

40mm / 4mm Pitch

WB383003

38mm / 3mm Pitch

WB404033

Haweka Steel ProGrip Quick Nut 40mm / 4mm Pitch

WB408005

Haweka Steel ProGrip Quick Nut Kit
40mm / 8mm Pitch

WB403033

Haweka Steel ProGrip Quick Nut 40mm / 3mm Pitch



WB28597050

Haweka Pro Grip Quick Nut Kit
28mm / 3mm Pitch



WB28937003

Haweka ProGrip Quick Nut Kit
28mm / 3mm Pitch. Replaces OEM Shaft
For Coats 700, 800, 825, 925, 950, 1000,
1025, 1050, 1055 And 1250



Kits Include:
Pro Grip, Shaft, Cup,
Ring And Cap



WB802

Pressure Cup For All Haweka Quick Release Nuts

WB805

Pressure Ring For All Haweka Quick Release Nuts

WB806

Rubber Cap for All Haweka Quick Release Nuts

WB109008021

Haweka Alloy WB Pressure Cup 8" Wide



WB802

WB805

WB806

WB109008021

Hub Nuts

HN61072

40mm Manual Hub Nut For FMC/John Bean Wheel Balancers
4mm Thread Pitch

O.E.M. Part Number
FMC/John Bean 61072



HN110543

28.5mm Manual Hub Nut For Coats Wheel Balancers For Coarse Thread Shaft
8mm Thread Pitch

O.E.M. Part Number
Coats 110543



HN112103

40mm Manual Hub Nut For Coats Wheel Balancers
8mm Thread Pitch

O.E.M. Part Number
Coats 112103



HN245053

38mm Manual Hub Nut For Corghi Wheel Balancers
3mm Thread Pitch

O.E.M. Part Number
Corghi 245053



HN83036

36mm Manual Hub Nut For Ranger And Rels Wheel Balancers
3mm Thread Pitch



HN408117

40mm Manual Hubnut For Hunter Wheel Balancers, Includes Spacer
8mm Thread Pitch



WHEEL BALANCER

Pressure Cups ▪ Shafts ▪ Wing Nuts

WB110542 Small Pressure Cup For HN110543 Hub Nut 28.5mm
 O.E.M. Part Number
 Coats 110542



WB112106 40mm Pressure Cup For HN112103 Hub Nut
 O.E.M. Part Number
 Coats 112106



WB1753531 4.5" Pressure Cup For Hunter Quick Release Nut
 O.E.M. Part Number
 Hunter 175-353-1



WB106822 4.5" Rubber Ring For Hunter Quick Release Nut
 Use With Pressure Cup WB1753531
 O.E.M. Part Number
 Hunter 106-82-2



WB1753921 6" Pressure Cup For Hunter Quick Release Nut
 O.E.M. Part Number
 Hunter 175-392-1



WB1061572 6" Rubber Ring For Hunter Quick Release Nut
 Use With Pressure Cup WB1753921
 O.E.M. Part Number
 Hunter 57-2



WB463202 Spacer For Hunter Pressure Cups
 O.E.M. Part Number
 Hunter 463202



WB112373 40mm Extended Threaded Shaft For FMC/John Bean Bal
 O.E.M. Part Number
 FMC/John Bean 112373



WB777
 Wheel Balancer Shaft Gauge
 Shaft & Thread Pitch

WB113082 40mm Conversion Shaft & Coupler For Coats Balancers
 O.E.M. Part Number
 Coats 113082



SELLING TOOL

WB113167C 28mm Stub Shaft For Coats Wheel Balancer (7" Length)
 O.E.M. Part Number
 Coats 113167C



Wheel Balancer Calipers & Gauge

WB309011 Wheel Caliper Measures Wheel Width
 1/2" And 1" Increments (up to 14")
 O.E.M. Part Number
 Accuturn 525010
 Coats 8309011
 John Bean 061123
 Hunter 221-563-1
 Snap-On EAA0247G21A



WB370500 Truck Wheel Caliper
 Measures Wheel Width
 In 1/2" And 1" (4" - 16")



WB113113 Bolt Hole Gauge
 For Flange Plates
 4,5 And 6 Lug Patterns



WHEEL BALANCER

Wheel Balancer Tools

TI33 Premium Wheel Weight Hammer
With Replaceable Nylon Cap



TI31 Cap For TI33
(4 Pack)



TI34 Heavy Duty Truck Wheel Weight Hammer



TI36 Premium Wheel Weight Hammer



TI38 Double Headed Wheel Weight Hammer



TI39 Wheel Weight Hammer/Plier



TI46 PDQ Style Wheel Weight Hammer/Plier



TI61 Wheel Weight Remover for Adhesive Weights (Black)



TI74 Wheel Weight Remover for Adhesive Weights (Red)



TI804 Heavy Duty Wheel Weight Plier Hammer



TI800 Cap For TI804





BRAKE LATHE

Carbide Bits

CB69	Round Positive Rake Carbide Bit				
	O.E.M.	Part Number	Brake Lathes		
	Ammco	40610	Application Based On Preference Of Insert		
Kwikway	109-6900-20	Application Based On Preference Of Insert			
CB6914-10	Negative Rake Carbide Bit .030 Radius (10 Pack)				
	O.E.M.	Part Number	Brake Lathes		
	Ammco	691410	1000•2002•3000•4000•4100•7000•7700 40420, 40430		
	FMC / John Bean	90817 (10 Pk)	505 On The Car		
	Hunter	221-580-2 (6 Pk) 221-617-2 (24 Pk)	BL300• BL500•BL505•OCL360•OCL400•OCL430MD		
Kwikway	109-6900-00	Not For Use On A Kwikway Lathe • Kwikway Part Number For Other Brands Reference			
CB7681-10	Positive Rake Carbide Bit .030 Radius (10 Pack)				
	O.E.M.	Part Number	Brake Lathes		
	Ammco	7681-2, 7681-6	4000•7000•800 OTV		
Hunter	212-583-3	BL300• BL500•BL505•OCL360•OCL400•OCL430MD			
CB50742	Positive Rake Carbide Bit				
	O.E.M.	Part Number	Brake Lathes		
Procut	50-742	For All Procut Lathes			
CB29687	Positive Rake Carbide Bit				
	O.E.M.	Part Number	Brake Lathes		
	Rel's	29687	204C•204D•204S•205DS•415		
Van Norman	866564	204C•204D•204S•205DS•243XV•415			
CB90488	Positive Rake Carbide Bit .20 Radius 15° Angle (10 Pack)				
	O.E.M.	Part Number	Brake Lathes		
	Ammco	40410	Not For Use On A Ammco Lathes • Ammco Part Number For Other Brands Reference		
	FMC/John Bean	90488	600•700		
Hofmann	W139 (5 Pk)	Trucut 400•401 On The Car•201 Standard•1115 HD Brake Lathes			
CB433796	Positive Rake Carbide Bit 11° Angle • 1/64" Radius (10 Pack)				
	O.E.M.	Part Number	Brake Lathes		
	Accuturn	433796	7700•8910•8911•8922•8944•8989		
Ammco	40435	Not For Use On A Ammco Lathes • Ammco Part Number For Other Brands Reference			
CB109-1092-23	Positive Rake Carbide Bit (10 Pack)				
	O.E.M.	Part Number	Brake Lathes		
	Ammco	40415	Not For Use On A Ammco Lathes • Ammco Part Number For Other Brands Reference		
	Hunter	221-639-3	BL300• BL500•BL505•OCL360•OCL400•OCL430MD		
Kwikway	109-1092-23	BDL•CBL•NDL•OCL			
CB221-626-3	Micro Mini Round Hunter Bit (10 Pack)				
	O.E.M.	Part Number	Brake Lathes		
Hunter	221-626-3	BL300• BL500•BL505•OCL360•OCL400•OCL430MD			

Tool Holders

BH69L&R	Positive Rake Left And Right Hand Toolholder Set For Round Bits Use With Ammco And Kwikway Brake Lathes			
BH9872	Negative Rake Toolholder For Drum Turning Use With Ammco Brake Lathes			
BH10650	Left Hand Tool Bit Holder. Tool Holder For BH10702 Use With Ammco 6950 And 6900 Twin Cutters			
BH10651	Right Hand Tool Bit Holder. Tool Holder For BH10701 Use With Ammco 6950 And 6900 Twin Cutters			

BRAKE LATHE

Tool Holders cont.

BH10701 **Negative Rake Right Hand Toolholder**
Use With Ammco And Hunter Brake Lathes



BH10702 **Negative Rake Left Hand Toolholder**
Use With Ammco And Hunter Brake Lathes



BH80337R **Right Hand Tool Bit Holder. Use With Micro Mini Bits**
Use With Hunter Brake Lathes



BH80337L **Left Hand Tool Bit Holder. Use With Micro Mini Bits**
Use With Hunter Brake Lathes



BH90489R&L **Curved Positive Rake Toolholder Set**
Use With FMC And Snap-On Brake Lathes



BH433763 **Positive Rake Right Hand Toolholder**
Use With Accuturn Brake Lathes



BH433764 **Positive Rake Left Hand Toolholder**
Use With Accuturn Brake Lathes



Arbors And Arbor Nuts

AN200	Standard 1" Arbor Nut		O.E.M.	Part Number
	O.E.M.	Part Number		
	Accuturn	433713	Performance	8543
	All Tool	5543	Rels	24074
	FMC / John Bean	90905	Van Norman	204074
	Hunter	76-338-2		



AN3102	Standard 1" Arbor Nut		Brake Lathe
	O.E.M.	Part Number	
	Ammco	3102	2002 • 3000 • 4000 4100 • 7000 • 7700

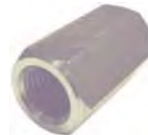

ANW220 **Arbor Nut For RJ West/ Hofmann AR 538 Arbor**



AR538 **1" Arbor For Hofmann / RJ West 10 1/2" Long**



AR3101 **Standard 1" Arbor For Ammco Brake Lathes**



AR8542 **Standard 1" Arbor For Hunter Brake Lathes**



AR9708 **11/16" Arbor Set (7 Pcs) For Ammco Brake Lathes**



AR90043 **Standard 1" Arbor For FMC, Snap-On, John Bean Lathes**



AR433701 **Standard 1" Arbor For Accuturn Lathes (10")**



AR97-422-2 **Standard 1" Arbor For Hunter Brake Lathes**



BRAKE LATHE

Boots And Accessories

SB3085 Spindle Protective Boot
O.E.M. Part Number Brake Lathe
 Ammco 3085 3000 • 4000
 4100 • 7700



SB3085Rub Spindle Protective Boot
O.E.M. Part Number Brake Lathe
 Ammco 3085 3000 • 4000
 4100 • 7700



SB3086 Small Cloth Protective Feed Screw Boot (10" Long)
O.E.M. Part Number Brake Lathe
 Ammco 3086 3000 • 4000



SB3087 Large Cloth Protective Cross Feed Boot - Length 8.5"
O.E.M. Part Number Brake Lathe
 Ammco 3087 3000 • 4000 • 4100
 7000 • 7700



BR23682 Bronze Boot Ring
O.E.M. Part Number Brake Lathe
 Ammco 23682 3000 • 4000
 4100 • 7700



Silencers

BS5 Heavy Duty 2 3/4" Truck Drum Silencer Band Length 6'



BS10 Adjustable Ventilated Rotor Silencer Band



BS17-2 Small Black Solid Rotor Silencer Band 6-9" Diameter (2 Pack)



BS22-2 Large Black Solid Rotor Silencer Band 10-12" Diameter (2 Pack)



BS80A Premium OEM 1 3/4 Drum Silencer Band Length 6'



CS1 Clip On Silencer



CS5 Silencer For Procut Lathes



SP9183-2 Replacement Silencer Pads For SB7075 Silencer Assembly



SB7075 Friction Rotor Silencer Assembly
O.E.M. Part Number Brake Lathe
 Ammco 7075 4000 • 4100 • 7000 • 7500



Components Available Individually

SB9800 Ventilated Rotor Spring Silencer Assembly (Length 25")



BRAKE LATHE

Adapters, Cones And Spacers

A, B, C AND E KITS

AS900001A Hub And Hubless Adapters For Most Cars Including Composites (18 Pcs)

Kit Includes:	O.E.M.	Part Number	
	Ammco	900001A	
SP3125	Ammco	3125	Spacer 1/2" (1 Pc)
AS9232	Ammco	9232	Double Taper Pass Car Adapter Set (5 Pcs)
AS9311	Ammco	9311	Auto Adapter Set (11 Pcs)
SP9492	Ammco	9492	Self Aligning Spacer (1 Pc)



AS900002B Same As AS900001A Plus Light Trucks Through 1/2 Ton (21 Pcs)

Kit Includes:	O.E.M.	Part Number	
	Ammco	900002B	
SP3125	Ammco	3125	Spacer 1/2" (1 Pc)
AS9232	Ammco	9232	Double Taper Pass Car Adapter Set (5 Pcs)
AS9310	Ammco	9310	Auto And Light Truck Adapter Set (14 Pcs)
SP9492	Ammco	9492	Self Aligning Spacer (1 Pc)

AS900003C Same As AS900002B Plus Light Trucks Through 1 Ton (32 Pcs)

Kit Includes:	O.E.M.	Part Number	
	Ammco	900003C	
SP3125	Ammco	3125	Spacer 1/2" (1 Pc)
AS9232	Ammco	9232	Double Taper Pass Car Adapter Set (5 Pcs)
AS9233	Ammco	9233	Double Taper Truck Adapter Set (2 Pcs)
AS9310	Ammco	9310	Auto And Light Truck Adapter Set (11 Pcs)
AS9313	Ammco	9313	Truck Adapter Set (9 Pcs)
SP9492	Ammco	9492	Self Aligning Spacer (1 Pc)

AS900006E For Most Cars And Light Trucks Through 1 Ton. Uses Double Chuck In Place Of Cones (15 Pcs)

Kit Includes:	O.E.M.	Part Number	
	Ammco	900006E	
AS8240	Ammco	41412	Double Chuck Adapter Kit (6 Pcs)
AS9232	Ammco	9232	Double Taper Adapter Set (5 Pcs) 1" Bore
AS9233	Ammco	9233	Double Taper Adapter Truck Set (2 Pcs) 1" Bore
SP3125	Ammco	3125	Spacer 1/2" Long (1 Pc)
SP9492	Ammco	9492	Self Aligning Spacer (1 Pc)

AS9310 Auto And Light Truck Adapter Set

AS9311 Auto Adapter Set

AS9312 Light Truck Adapter Set

AS9313 Truck Adapter Set

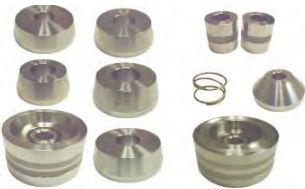

AS9311

AS9313



AS70040 Quick Chuck Adapter Backing Plate / Key (3 Pcs)



AS9232 Double Taper Adapter Set. (5 Pcs) For Passenger Cars And Some Light Trucks



AS8240 Lite Dual Chuck Adapter Kit (6 Pcs)



AS9394 Economy Light Truck Adapter Set 1" Bore (5 Pcs)



AS9233 Double Taper Adapter Set For Trucks. (2 Pcs)



AS5532 Rotor Adapter Kit. Machining Late Model F-150 2 Wheel Drives Without Removing The Bearings.



AS4790 1 7/8" To 1" Step Down Adapter (Set Of 3)



AS3577 6 1/2" Alignment Cup 1" Bore
AS3578 7 3/4" Alignment Cup 1" Bore



SP9492 Self Aligning Spacer



BRAKE LATHE

Brake Lathe Accessories

MO2165 1 H. P. Motor. Motor Only For Ammco Lathes.
Does Not Fit 3850 Lathe



VB3161 Drive V-Belt (Replaces 4L-250)



BP3141-30 Brass Plug Approximately 3/16" Diameter (30 Pk)
BP3142-30 Brass Plug Approximately 5/16" Diameter (30 Pk)
BP9836-30 Brass Plug Approximately 1/4" Diameter (30 Pk)



OS3163 Small Input Shaft Oil Seal



OS3164 Large Front And Rear Oil Seal



KB6854 Red 3 Arm Knob
O.E.M. Part Number Brake Lathe
Ammco 6854 3000 • 3850 • 4000
4100 • 7000 • 7500
7700



CF6936 Cross Feed Extension For TC6950 Twin Cutter
O.E.M. Part Number
Ammco 6936



TC6950 Twin Cutter For Ammco Lathes
O.E.M. Part Number
Ammco 6950



PT7980 Blue Paint (Case Of 12)



SG7996 Shear Gear And C Clip For Ammco Brake Lathes
O.E.M. Part Number Brake Lathe
Ammco 7996 3000 • 3850 • 4000
4100 • 7000 • 7500
7700



GP8756-12 Grinder Pads (120 Grit)
Use With ST8740 Swirl Finisher
4" Diameter-Adhesive Back)



SS9481 Safety Shield Kit For Ammco 6900, 6950,
And 7900 Twin Cutters (Includes Hardware)



LS10868X Rotor Disc Box Lead Screw Nut



NA11227 Nut Assembly
Use With ST 25913 Long Stud



BRAKE LATHE

Brake Lathe Accessories cont.

BR23682 Bronze Boot Ring
Use With SB 3085 Spindle Boot



LS28529 Lead Screw Nut Service Kit
For Ammco Lathes



PU40175 2 Step 2 Speed Serpentine Pulley Set And Belt



VB40141 Drive V-Belt For PU 40175
(200J Six Rib Poly V-Belt)



IP7747-10 Old Style Index Plate For Disc Box
On Ammco 4000 Lathes



WL7963 Work Lamp For Ammco Lathes



RS433156 Rotor Feed Screw For Accuturn Lathes



DS433157 Drum Feed Screw For Accuturn Lathes



SM433641 Feed Motor For Accuturn Lathes 1/60 HP 6 RPM
120 Volt, 60 Hz, 1.5 Amps (Includes Fan)

SM4135
Fan For SM433641



WC433735 Way Cover For Accuturn Lathes

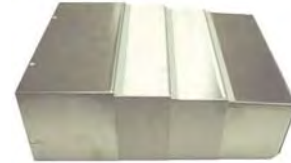

SS436056 Universal Chip Safety Shield
(superseded CS11154)



VB433673 Cogged Drive V-Belt For Accuturn Lathes



BR49276 Blue Silicone Gasket Maker
8oz Net Auto Can



BR49452 Red Hi Strength Threadlocker
24ML Bottle



BR49593 Brake System Silicone Compound
5.3oz Tube



ALIGNMENT

Turn Plates And Alignment Accessories

SS6500P Stainless Steel Turn Plate Set
14" x 14" x 1 1/2" With Pointer



SS7500 Stainless Steel Turn Plate Set
14" x 14" x 1 1/2" Without Pointer



MS3400 Powder Coated Mild Steel Turn Plate Set
14" x 14" x 1 1/2" Without Pointer



MS4500 Heavy Duty Powder Coated Mild Steel Turn Plate Set
For Any Over The Road Heavy Duty Truck
18" x 18" x 2.5" Without Pointer



SS6700 Standard Turn Plate Repair Kit.
Kit Includes: 54 Pcs 9/16" Derlin Balls,
4 Pcs Lock Pins,
2 Pcs Retainer With Spring Assemblies
2 Pcs Set Screw, 2 Pcs Top Screw



SS6980 Heavy Duty Stainless Steel Turn Plate Repair Kit
Kit Includes: 108 Pcs 9/16" Derlin Balls,
4 Pcs Lock Pins, 8 Pcs Springs
2 Pcs Double Row Retainers
2 Pcs Set Screw, 2 Pcs Top Screw,



SS6600 9/16" Delrin Bearings
For Turn Plates.
54 Per Bag



SS6650 Repair Kit
For MS3400, SS6500
And SS7500 Turn Plates



BP125 Steering Wheel Holder



BP130 Brake Pedal Depressor



WATER SEPARATORS

TI9820 TSUNAMI 120 SCFM Water Separator
Flow Rating - 120; 250 Max PSI;
200 Max Temp Port - 1" NPT;
15 7/8" x 3 1/8"



TI9580 TSUNAMI 50 SCFM Water Separator
Flow Rating - 50; 250 Max PSI;
200 Max Temp Port - 1/2" NPT;
14 1/4" x 2 3/8"

TI9800 Water Separator / Lubricator
Bolts On Machine,; Flow Rating - 20;
250 Max PSI; 150 Max Temp;
25 Microns; Manual Drain;
Port - 1/4" NPT; 8 1/2" x 2"



TI9700 TSUNAMI Water Separator / Lubricator
Bolts On Machine : Flow Rating - 20;
250 Max PSI; 150 Max Temp;
10 Microns; Float Drain;
Port - 1/4" NPT; 8 1/2" x 2"



LIFT PADS

 <p>LP600 Molded Rubber Pad For Ammco / Ben Pearson Challenger / Weaver (3 3/4" x 5 3/4" x 3/4") 3 1/4" Between Bolt Holes 4 Piece Kit</p>				 <p>LP601 Molded Rubber Pad For Benwil / Bishamon (4 1/2" x 3 5/8" x 3/4") 1 7/8" (W) Between Bolt Holes 1 5/8" (L) Between Bolt Holes 4 Piece Kit</p>
 <p>LP602 Heavy Die Cut Material For Challenger VBM Round (5 7/8" x 5 7/8" x 1/4") 3" Between Bolt Holes 4 Piece Kit</p>	 <p>LP603 Rough Heavy Die Cut Material (8 Sided) For Forward / Eagle / Gemini / Worth / American (Pad Only 5" x 5" x 1/4") 3 3/4" Between Bolt Holes 4 Piece Kit</p>	 <p>LP605 Molded Rubber Pad For Nussbaum / Phoenix / Force(Old) (5" x 1") 3 1/2" Between Bolt Holes 4 Piece Kit</p>	 <p>LP606 Heavy Die Cut For Flip Up Height Extensions (Pad Only 5 1/2" x 3" x 1/4") 3 1/8" Between Bolt Holes 4 Piece Kit</p>	 <p>LP607 Molded Rubber Pad For Western/American Slip On (4 1/2" x 4" x 1") 4 Piece Kit</p>
 <p>LP608 Bend Pak Square (Slip On) Molded Rubber Pad (5 1/2" x 5 1/2" x 1") 4 Piece Kit</p>	 <p>LP609 Heavy Duty Cut Material For Rotary SPO 12 (4" x 3 1/4" x 1/4") 3" (W) Between Bolt Holes 2 3/8" (L) Between Bolt Holes 4 Piece Kit</p>	 <p>LP610 Molded Rubber Pad For Wheeltronics / Snap-On / Ammco-Square (5 1/4" x 4 1/2" x 1") 4 Piece Kit</p>	 <p>LP612 Lift Pads For Globe Heavy Die Cut Material (4 1/2" x 3/8") 4 Piece Kit</p>	 <p>LP613 Solid Molded Rubber Block Pad (6" x 4 3/4" x 3") 4 Piece Kit</p>
 <p>LP615 Solid Molded Rubber Block Pad (6 1/4" x 4 3/4" x 1 1/2") 4 Piece Kit</p>	 <p>LP616 ALM Lift Pads Molded Rubber Pad(Like OEM) (6 1/4" x 1.125") 4 Piece Kit</p>	 <p>LP617 Rubber Pad for Challenger CL9 & CL10 (Like OEM) (4" x 4" x 7/16") 4 Piece Kit</p>	 <p>LP618 Bend Pak Square Bolt-On Molded Rubber Pad (5 1/2" x 5 1/2" x 1") 3 5/8" (W) Between Bolt Holes 3 5/8" (L) Between Bolt Holes 4 Piece Kit</p>	 <p>LP619 Molded Rubber Pad for Wheeltronics / Snap-On / AMMCO Round (Bolt On) (4.812" x 1.125") 4 Piece Kit</p>
 <p>LP620 Round Rubber Pad For Challenger (5 1/2" x 3/4") 4 Piece Kit</p>	 <p>LP621 Molded Rubber Pad For Globe (3" x 4 1/2" x 1") 2 3/8" (W) Between Bolt Holes 1 5/8" (L) Between Bolt Holes 4 Piece Kit</p>	 <p>LP622 Molded Rubber Pad For Quality (4 3/4" Round) 4 Piece Kit</p>	 <p>LP623 Challenger/ VBM Round Heavy Molded Material (3/8" Round) 3" Between Bolt Holes 4 Piece Kit</p>	

TPMS SMART SENSOR

The Smart TPMS Program For TPMS Service And Sensor Replacement

**Efficient
Effective**



- 2 Sensors Cover 95% of Domestic Makes and 85% of Import Makes
- **PROGRAM** < Blank Smart Sensors For Direct Replacement Of OE Sensors
- **COPY** < The ID# Of An OE Sensor Into The Smart Sensor And Avoid Having To Relearn Many Makes Of Vehicles.
- Pro+ Tool Is Also A Sensor Activation Tool – Will SCAN And Diagnose ALL Sensors



TS0144
Pro Tool - Smart Sensor
TPMS Programming Activation Tool
• Quick Start Guide
• USB Cable • User Guide CD
• TPMS Nut Removal Tools
• Batteries And Battery Charger



TS3013
315 MHz Programmable
TPMS Sensor
Green



TS4413
433.92 MHz Programmable
TPMS Sensor
Brown

TR23018
Black Replacement Valve
And Service Kit



TR24019
Aluminum Replacement Valve
And Service Kit



TR20014
Service Replacement Kit



TS0055
ATEQ VT55 OBDII TPMS Tool Kit
• Relearns Sensors And System
• Triggering Electronic & Magnetically Activated Sensors
• Diagnosis If Sensor Are Functioning Properly



TS0100
TPMS T.I.P.S.© Tool
• Triggering Electronic & Magnetically Activated Sensors
• Diagnosis If Sensor Are Functioning Properly
• Updatable

TPMS TOOLS & REPLACEMENT PARTS

TI114
Long Plastic Sealing Cap
 For TR20008 TPMS Valve
 (100 Per Box)



TI108
Chromed Plastic Sealing Caps
 For TPMS Application
 (100 Per Box)



TI119
Green Long Plastic Sealing Cap
 For TR20008 TPMS Valve
 (100 Per Box)



TI111
Chromed Plastic Sealing Caps
 For TPMS Application
 With Green Nitro I.D. Tip
 (100 Per Box)



*Chromed Plastic
 Will Not
 Cause Corrosion*

TR25306
Standard TPMS Gray Sealing Cap
 (100 Per Box)



TI116
Chromed Plastic Sealing Cap
 For TPMS Application
 Long Skirted Cap
 (Box of 100)



TI117
Green Plastic Sealing Cap With Seal
 (Box of 100)



TR208CS
Chromed Plastic Sleeve
 For TR20008
 TPMS Replacement Stem
 (100 Per Box)



TR25040
 TPMS Nickel
 Plated Cores
With Yellow Band
 (100 Per Box)



OPK860
 TPMS Sealing Cap Kit Plastic And
 Chromed Plastic Sealing Caps (320 Pcs)

TR24050
3" Cable TPMS Sensor Tool



TR24000
TPMS 4-Way Sensor Tool
 • 11mm Sensor Nut Tool
 • 12mm Sensor Nut Tool
 • Non Beveled Grommet Tool
 • Beveled Grommet Tool



TR3569
TPMS Grommet Pick Removal Tool



TR25985
T-10 TPMS Torque Tool (11.5 in-lbs)
 Use When Replacing
 TPMS Snap-In Style Valve Stems.
 Comes With 3 Tips And
 Are Easily Replaced.



TR25005
TPMS Torque Tool
 With A Torque Specification
 Of 4 Inch Pounds Use When Tightening
 TPMS Valve Cores To Prevent
 Over Tightening Which
 Can Damage The TPMS Valve.

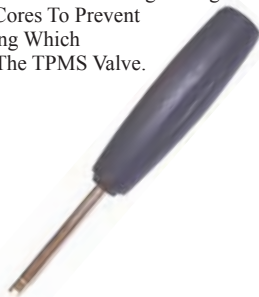

TR24200
**TPMS Grommet Removal
 And Installation Tool**
 • Designed To Safely Remove
 The Rubber Grommet From The Stems
 On Clamp-In And Bolt-On TPMS Sensors
 • Can Be Used For Installation Of New Grommet



TR3480
 Grommet Slide Removal
 And Installation Tool (5 1/4" Long)



TR1194
**Universal Band For
 Ford TPMS**
 Adjustable 14" - 26"



TR1015
1/4" Nut Driver and 11mm/12mm Socket Kit



TR2911
 11mm Deep Socket, 1/4" Drive
TR2912
 12mm Deep Socket, 1/4" Drive



TR1000
 1/4" Extension
 For Use With TR1112



TR1112
 11mm / 12mm Flip Socket
 For TPMS Application



TR1012
 1/4" Extension And
 11mm/12mm Socket Kit



TR1125
**TPMS Ford
 Replacement
 Cradle**



TPMS ASSORTMENTS

TI108	Chromed Cap Plastic Hex Cap	50 Pcs
TI111	Chromed Plastic Hex Cap With Green ID	20 Pcs
TI114	Long Plastic Cap For TR20008 TPMS Valve	100 Pcs
TI116	Chromed Plastic Long Skirted Cap	50 Pcs
TI117	Green Plastic Cap (With Seal)	20 Pcs
TR018	TPMS Replacement Parts Kit For Snap-In Valve Ford	2 Pcs
TR208CS	Chromed Plastic Sleeve For TR20008 TPMS Replacement Stem	16 Pcs
TR20008	Rubber Snap In Style TPMS Replacement Stem	12 Pcs
TR25040	TPMS Nickel Plated Cores With Yellow Band	100 Pcs
TR25306	Standard TPMS Gray Cap	50 Pcs

OPK844
TPMS Master Cap Assortment
(422 Pieces)



TI108	Chromed Cap Plastic Hex Cap	25 Pcs
TI114	Long Plastic Cap For TR20008 TPMS Valve	10 Pcs
TR1112	1/4" Dr. x 11mm x 12mm Chrome Flip Socket	1 Pc
TR25040	TPMS Nickel Plated Valve Cores With Yellow Band	1 Pc
TR25985	Torque Tool For TR200008 TPMS Replacement Stem	1 Pc
TR25306	Standard TPMS Gray Cap	25 Pcs
TR25005	TPMS Valve Core Torque Tool	1 Pc
TR20008	Rubber Snap In Style TPMS Replacement Stem (interchangeable with 20018 for 20315)	10 Pcs
TR20028	For Cadillac, Chevrolet, Chrysler, Dodge, Jeep, Mitsubishi	8 Pcs
TR20096	For Ford, Lincoln, Mercury	8 Pcs
TR20107	For Buick, Cadillac, Chevrolet, GMC	8 Pcs
TR20201	For Buick, Chevrolet, Chrysler, Dodge, GMC, Jaguar, Land Rover, Mazda, Mitsubishi, Pontiac, Saturn	8 Pcs

OPK825
TPMS Accessory Kit (106 Pcs)
"Most Popular Service Kits"



TR20005	For Infiniti, Nissan	8 Pcs
TR20006	For GMC, Hummer, Isuzu	6 Pcs
TR20007	For Infiniti, Nissan	8 Pcs
TR20028	For Cadillac, Chevrolet, Chrysler, Dodge, Jeep, Mitsubishi	10 Pcs
TR20107	For Buick, Cadillac, Chevrolet, GMC	10 Pcs
TR20202	For Audi, Mercedes-Benz, Volkswagen	6 Pcs
TR20211	For Audi, Bentley, BMW, Beatty, Ferrari, Land Rover, Maserati, Mercedes-Benz, Porsche, Volkswagen	6 Pcs
TR20035	For Honda	4 Pcs
TR20036	For Acura, Honda, Hyundai, Kia	4 Pcs
TR20096	For Ford, Lincoln, Mercury	8 Pcs
TR20201	For Buick, Chevrolet, Chrysler, Dodge, GMC, Jaguar, Land Rover, Mazda, Mitsubishi, Pontiac, Saturn	10 Pcs
TR20203	For Mercedes-Benz	6 Pcs
TR20206	For Acura, Honda, Hyundai, Kia	10 Pcs
TR20216	For Lexus, Toyota	8 Pcs
TR20217	For Lexus, Toyota	8 Pcs
TR20221	For Lexus	6 Pcs
TR25005	TPMS Valve Core Torque Tool	1 Pc
TR25040	TPMS Nickel Plated Valve Cores	100 Pcs
TR25306	Standard TPMS Gray Cap	100 Pcs

OPK875
TPMS Kit Assortment 16 Kits
For A Total Of 118 Kits,
100 Caps And Cores, 1 Torque Tool



OPK860
TPMS Sealing Cap Kit
Plastic And Chromed
Plastic Sealing Caps (320 Pcs)

TI108	Chromed Cap Plastic Hex Cap	50 Pcs
TI111	Chromed Cap Plastic Hex Cap With Green ID	20 Pcs
TI114	Long Plastic Cap For TR20008 TPMS Valve	60 Pcs
TI116	Chromed Plastic Long Skirted Cap	20 Pcs
TI117	Green Plastic Cap With Seal	20 Pcs
TR25306	Standard TPMS Gray Cap	50 Pcs
TR25040	TPMS Nickel Plated Valve Cores	100 Pcs



TPMS SENSORS

Schrader Sensors

TS1048 TPMS Banded Sensor For Ford, Lincoln And Mazda
TS20028 TPMS Sensor - Chrysler, Dodge, Isuzu, Jeep, Mitsubishi OE# 5208-8990AC
TS20034 TPMS Sensor - Mitsubishi OE# MN103081
TS20064 TPMS Sensor - Infiniti, Nissan OE# 40700-CD001
TS20066 TPMS Sensor - Chrysler, Dodge, Jeep OE# 5605-3036AA, 5605-3030AB, 6800-169966AA, SE57770
TS20069 TPMS Sensor - Infiniti, Nissan OE# 40700-CK002
TS20076 TPMS Sensor - Cadillac, Chevrolet OE # 25758220
TS20081 TPMS Sensor - Subaru OE# 28103-AG00A
TS20082 TPMS Sensor - Suzuki OE# 96484045
TS20087 TPMS Sensor - Suzuki OE# 4313054J20
TS20096 TPMS Sensor - Ford, Lincoln, Mercury OE# 4L2T-1A150-BA
TS20107 TPMS Sensor - Cadillac, Chevy, GMC OE# 15114379
TS20115 TPMS Sensor - Cadillac, Chevy, GMC OE# 15136883
TS20116 TPMS Sensor - Cadillac, Chevy, GMC, Isuzu OE# 25774005
TS20117 TPMS Sensor - Cadillac, Chevrolet OE# 25773946
TS20131 TPMS Sensor - Cadillac, GMC, Hummer OE# 15122618
TS20135 TPMS Sensor - Ford, Lincoln OE# 9L321189A
TS20153 TPMS Sensor - Snap-in - Buick, Cadillac, Chevy, GMC, Hummer OE# 70503153
TS20156 TPMS Sensor - Volvo OE# 8651700
TS20158 TPMS Sensor - Buick, Cadillac, Chevy, GMC,



TS20315 TPMS Sensor - Ford Snap-In OE# 9L3Z1189A
TS20335 TPMS Sensor - Chrysler, Dodge OE# 04727392AD, 5127-335AB, 5127-335AD, SE57243
TS28004 TPMS Sensor - Chrysler, Plymouth OE# 04815132AB
TS28006 TPMS Sensor - Chevrolet OE# 10438853
TS28078 TPMS Sensor - Saab OE# 24437708
TS28129 TPMS Sensor - Mitsubishi OE# 4250A030
TS28154 TPMS Sensor - Chrysler OE# 56029319AA
TS28155 TPMS Sensor - Jeep
TS28167 TPMS Sensor - Nissan #40700JA01A
TS28203 TPMS Sensor - Subaru OE# 28103AG01A
TS28204 TPMS Sensor - Nissan OE# 40700JA01B
TS28210 TPMS Sensor - Infiniti
TS28214 TPMS Sensor - Mercedes OE# 0045421518
TS28291 TPMS Sensor - Chrysler
TS28300 TPMS Sensor - Toyota OE# 426070C010, 42607-04010
TR28305 TPMS Sensor - Toyota OE# 426070C020
TS28380 TPMS Sensor - Toyota OE# 42607AD010
TS28395 TPMS Sensor - Ford Banded OE# 8C2Z1A189A
TS28670 TPMS Sensor - Toyota OE# 426070C050
TS28720 TPMS Sensor - Honda
TS28849 TPMS Sensor - Hyundai, Kia OE# 529332F000
TS28981 TPMS Sensor - Acura, Honda OE# 06421-S3V-AD2

Beru Sensors

TSE001 TPMS Sensor - Audi, Mercedes, Volkswagen OE# RDE 001
TSE002 TPMS Sensor - BMW OE# RDE 002
TSE004 TPMS Sensor - Audi, Mercedes, Volkswagen OE# RDE 004
TSE007 TPMS Sensor - Audi, Mercedes, Volkswagen OE# RDE 007

TSE005 TPMS Sensor - Porsche, Volkswagen OE# RDE 005
TSE003 TPMS Sensor - BMW, Land Rover OE# RDE 003
TSE008 TPMS Sensor - BMW OE# RDE 008
TSE010 TPMS Sensor - Porsche OE# RDE 010

Lear Sensors

TS52933-4D200 TPMS Sensor-Hyundai, Kia OE # 52933-4D200



Pacific Sensors

TSSTK-A02 TPMS Sensor - Acura OE# 42753-STK-A02
TSTL2-A52 TPMS Sensor - Acura OE# 42753-TL2-A52
TSSA2-315 TPMS Sensor - Honda OE# 42753-SA2-315
TSSWA-305 TPMS Sensor - Honda OE# 42753-SWA-305
TSSWA-306 TPMS Sensor - Honda OE# 42573-SWA-306
TSSZA-A12 TPMS Sensor - Honda OE# 42753-SZA-A12
TJK00B TPMS Sensor - Infiniti OE# 40700JK00B
TS28300 TPMS Sensor - Toyota OE# 426070C010, 42607-04010
TS28305 TPMS Sensor - Toyota OE# 42607-AD020, 426070C010

TS28310 TPMS Sensor - Lexus OE# 42607-24010
TS28315 TPMS Sensor - Lexus OE# 42607-24020
TS28320 TPMS Sensor - Lexus OE# 42607-24030
TS28325 TPMS Sensor - Lexus, Toyota OE# 42607-24040
TS28335 TPMS Sensor - Lexus OE# 42607-30030
TS28360 TPMS Sensor - Toyota, Pontiac OE# 42604-06011
TS28365 TPMS Sensor - Lexus, Pontiac, Scion,
TS28370 TPMS Sensor - Lexus, Toyota OE# 42607-33021
TS35011 TPMS Sensor - Lexus, Toyota OE# 42607-350110

Siemens (Continental) Sensors

TS55001 TPMS Sensor - Audi, Volkswagen OE# SE55001
TS53007 TPMS Sensor - Buick, Cadillac, Chevrolet, GMC, Pontiac, Saturn OE# SE53007
TS57243 TPMS Sensor - Chrysler, Dodge OE# SE57243
TS57771 TPMS Sensor - Chrysler, Dodge OE# SE57771
TS57770 TPMS Sensor - Chrysler, Dodge, Jeep OE# SE57770
TS58003 TPMS Sensor - Dodge OE# SE58003
TS53001 TPMS Sensor - Jaguar, Land Rover OE# SE53001



TS53002 TPMS Sensor - Jaguar, Land Rover OE# SE53002
TS53003 TPMS Sensor - Land Rover OE# SE53003
TS53005 TPMS Sensor - Mazda OE# SE53005
TS58001 TPMS Sensor - Mercedes OE# SE58001
TS58002 TPMS Sensor - Mercedes OE# SE58002
TS55002 TPMS Sensor - Volkswagen OE# SE55002
TS51002 TPMS Sensor - Volvo OE# SE51002

TRW Sensors

TS222720-104 TPMS Sensor - Acura OE# 222720-104
TS218898-101 TPMS Sensor - Acura, Honda, Kia OE# 218898-101
TS222720-103 TPMS Sensor - Honda OE# 222720-103
TS218898-102 TPMS Sensor - Honda OE# 218898-102

TS218898-103 TPMS Sensor - Honda, Hyundai, Kia OE# 218898-103
TS221849-101 TPMS Sensor - Hyundai, Kia OE#221849-101
TS221849-102 TPMS Sensor - Hyundai, OE# 221849-102
TS221670-101 TPMS Sensor - Toyota, OE# 221670-101

TPMS REPLACEMENT PARTS KITS

<p>TR20005 TPMS Replacement Parts Kit For Infiniti, Nissan</p> 	<p>TR20006 TPMS Replacement Parts Kit For GMC, Hummer, Isuzu</p> 	<p>TR20007 TPMS Replacement Parts Kit For Infiniti, Nissan</p> 	<p>TR20008 Rubber Snap In Style TPMS Replacement Stem For GM</p> 
<p>TR20009 TPMS Replacement Parts Kit For Saab, Suzuki</p> 	<p>TR20010 TPMS Replacement Parts Kit For Volvo</p> 	<p>TR20011 TPMS Replacement Parts Kit For Subaru</p> 	<p>TR20012 TPMS Replacement Parts Kit For Prowlter, Corvette</p> 
<p>TR20013 TPMS Replacement Parts Kit For Chrysler, Dodge, Jeep</p> 	<p>TR20014 TPMS Replacement Parts Kit For Nissan, Infiniti</p> 	<p>TR20015 TPMS Replacement Parts Kit For GM With TRW Clamp-In</p> 	<p>TR20016 TPMS Replacement Parts Kit For Mercedes.</p> 
<p>TR20020 TPMS Replacement Aluminum Stem ForChrysler / Dodge</p> 	<p>TR20028 TPMS Replacement Parts Kit For Cadillac, Chevrolet, Chrysler, Dodge, Jeep, Mitsubishi</p> 	<p>TR20035 TPMS Replacement Parts Kit For Honda. Same As TR 20206, but includes a LONG Valve</p> 	<p>TR20036 TPMS Replacement Parts Kit For Acura, Honda, Hyundai, Kia. Same As TR 20206, but includes a SHORT Valve</p> 
<p>TR20096 TPMS Replacement Parts Kit For Ford, Lincoln, Mercury</p> 	<p>TR20107 TPMS Replacement Parts Kit For Buick, Cadillac, Chevrolet, GMC</p> 	<p>TR20198 TPMS Replacement Parts Kit For Dodge Sprinter</p> 	<p>TR20201 TPMS Replacement Parts Kit For Buick, Chevrolet, Chrysler, Dodge, GMC, Jaguar, Land Rover, Mazda, Mitsubishi, Pontiac, Saturn</p> 
<p>TR20202 TPMS Replacement Parts Kit For Audi, Mercedes-Benz, Volkswagen</p> 	<p>TR20203 TPMS Replacement Parts Kit For Mercedes-Benz</p> 	<p>TR20204 TPMS Replacement Parts Kit For Acura, Honda, Kia</p> 	<p>TR20206 TPMS Replacement Parts Kit For Acura, Honda, Hyundai, Kia</p> 
<p>TR20211 TPMS Replacement Parts Kit For Lexus</p> 	<p>TR20216 TPMS Replacement Parts Kit For Lexus, Toyota</p> 	<p>TR20217 TPMS Replacement Parts Kit For Lexus, Toyota</p> 	<p>TR20221 TPMS Replacement Parts Kit For Lexus</p> 

SCHRADER SERVICE PACKS

<p>TR002 TPMS Replacement Parts Kit For Ford, Lincoln, Mercury</p> 	<p>TR003 TPMS Replacement Parts Kit For Cadillac, Chevy, Chrysler, Dodge, Isuzu, Jeep, Mitsubishi</p> 	<p>TR004 TPMS Replacement Parts Kit For Buick, Cadillac, Chevy, GMC, Hummer, Isuzu</p> 
<p>TR005 TPMS Replacement Parts Kit For Infiniti, Nissan</p> 	<p>TR006 TPMS Replacement Parts Kit For Chevy, GMC, Hummer</p> 	<p>TR007 TPMS Replacement Parts Kit For Infiniti, Nissan</p> 
<p>TR008 TPMS Replacement Parts Kit For Snap-In Valve, Buick, Cadillac, Chevrolet, GMC, Hummer</p> 	<p>TR009 TPMS Replacement Parts Kit For Suzuki</p> 	<p>TR010 TPMS Replacement Parts Kit For Volvo</p> 
<p>TR011 TPMS Replacement Parts Kit For Subaru</p> 	<p>TR012 TPMS Replacement Parts Kit For Chevrolet, Chrysler, Plymouth</p> 	<p>TR013 TPMS Replacement Parts Kit For Chrysler, Dodge, Jeep</p> 
<p>TR014 TPMS Replacement Parts Kit For Nissan</p> 	<p>TR015 TPMS Replacement Parts Kit For Cadillac, Chevy, GMC, Hummer</p> 	<p>TR016 TPMS Replacement Parts Kit For Mercedes</p> 
<p>TR017 TPMS Replacement Parts Kit For Volkswagen</p> 	<p>TR018 TPMS Replacement Parts Kit For Snap-In Valve Ford</p> 	<p>TR030 TPMS Replacement Parts Kit For Buick, Chevy, Chrysler, Dodge, Jeep, Land Rover, Mazda</p> 
<p>TR031 TPMS Replacement Parts Kit For Lexus, Toyota</p> 	<p>TR032 TPMS Replacement Parts Kit For Toyota</p> 	<p>TR035 TPMS Replacement Parts Kit For Honda</p> 
<p>TR036 TPMS Replacement Parts Kit For Acura, Honda, Hyundai, Kia (Short Valve)</p> 		

TIRE REPAIR TOOLS

Tire Repair Tools

TI10 2 1/2" Tungsten Coated Buffing Wheel - 36 Grit



MI990 Wire Brush
4 3/4 x 3/4 Brush Head, 10 1/4" Overall Length



TI16 Open Eye Needle Die Cast T-Handle
And Open Eye Needle



TI54 Barbed Rasp With Screwdriver Type Handle,
3" Non-Replaceable Rasp



TI59 Open Eye Needle With Plastic T-Handle,
3" Non-Replaceable Needle



TI65 U.S. Made TV-2 Screwdriver Valve Core Tool
For Inserting And Removing Valve Cores.
Safety Grip Black And Red Screwdriver Handle.
Stamped Made In U.S.A.



TI69 Ball Bearing Stitcher With Wooden Handle,
1 1/2" Wheel Diameter, 3mm Thickness



TI76 Poly Valve Stem Inserting Lever / Valve Installation Tool
Installs Tire Valves Without Scratching The Rim.
(Screw On Type) Green



TI15 Threaded Arbor For TI 10 Buffing Wheel



MI4225 4" Twisted Wire Brush
3/8" Center Hole, 20,000 RPM



TI48-2 Metal T-Handle Tool With Spiral Probe
(Socket Key And Screw Included)
Sold Pack Of 2 Only



TI62 Power Rasp With Screwdriver Type Handle



TI67 Spiral Probe With Plastic Pistol Grip Handle,
4" Non-Replaceable Probe



TI612 U.S. Made Screwdriver Valve Core Tool
(5 1/4" shaft)
Safety Grip Black And Red Screwdriver Handle
Stamped Made In U.S.A.



TI44 Steel Valve Puller With Rubber Block



TI77 Carbon Steel Valve Stem Puller Tool
Nickel Chrome Plated To Resist Erosion
(Screw On Type)



TIRE REPAIR

Technicians Choice Tire Repairs

- TI701 Small Round All Purpose Repair, 1 5/8", 43mm
 TI702 Medium Round All Purpose Repair, 2 1/4", 57mm
 TI703 Large Round All Purpose Repair, 3 1/8", 79mm
 TI710 Medium Oval All Purpose Repair, 1 7/8 x 3 3/4

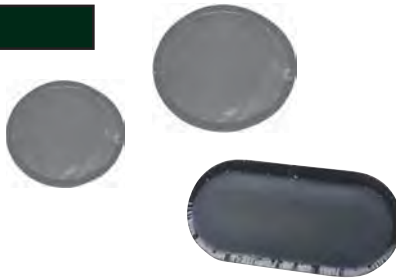

- Feather-Edge Tube Repair**
- Designed For Chemical Vulcanization
 - Black Vulcanizing Gum, White Poly

- TI720B Square Universal Blue Poly, 1 3/4"
 TI722R Square Universal Red Poly, 2 1/8"



- Square Universal Repair**
- Designed For Chemical Vulcanization
 - Gray Vulcanizing Gum, Red Or Blue

- TI731 Small Round Universal Repair, 1 3/4"
 TI732 Medium Round Universal Repair, 2"
 TI733 Large Round Universal Repair, 3 1/8"



- Standard Universal Repair**
- Designed For Chemical Vulcanization
 - Black Vulcanizing Gum, Blue Poly

- TI740 Dual Cure Radial Repair, 1 3/4 x 3
 TI741 Dual Cure Radial Repair, 2 1/4 x 3
 TI742 Dual Cure Radial Repair, 2 1/4 x 4
 TI743 Dual Cure Radial Repair, 3 3/4 x 4
 TI744 Dual Cure Radial Repair, 3 x 5



- COI Radial Repair**
- Designed To Vulcanize Chemically Or In A Low Temperature System
 - Gray Vulcanizing Gum, Blue Poly Backing

Technicians Choice Insert Repairs

- TI766 Fiber-Seal Inserts. Gray Vulcanizing Gum Coated. Wrapped In Blue Protective Poly And Have A Reinforcing Core Of Fiber



- Fiber-Seal Insert Repair**
- For Use In Radial And Bias Ply Tires
 - Designed For Chemical Vulcanization
 - Wrapped In Blue Protective Poly

- TI810 Bowtie Style Inserts, 5-Ply Orange Bowtie



- Bow Tire Insert Repair**
- For Use In Radial And Bias Ply Tires
 - Designed For Chemical Vulcanization

- TI651 1/4" Lead Wire Inserts
 TI652 3/8" Lead Wire Inserts
 TI653 7/16" Lead Wire Inserts



QUICK AND EASY INSTALLATION

- Lead Wire Insert Repair**
- For Use In Radial And Bias Ply Tires
 - Designed For Chemical Or Heat Vulcanization
 - Dip Coated With Premium Blue Vulcanizing Gum
 - **No Special Tools Required: Use Carbide Cutter To Prepare The Injury, Install From The Inside, Pull Through, And Cut Off The Wire.

TIRE REPAIR

Technicians Choice Insert Repairs

ST9US 7" Thin Tire String Repair
(Traditional Black) Non Vulcanizing U.S. Made
50 Repairs Per Box / 36 Boxes Per Case



ST1933US 4" Thick Radial Tire String Repair
(Red / Brown) Self Vulcanizing U.S. Made
60 Repairs Per Box / 36 Boxes Per Case



ST1937US 7 1/4" Thick Radial Truck Tire String Repair
(Red / Brown) Self Vulcanizing U.S. Made
30 Repairs Per Box / 36 Boxes Per Case



ST4204US 4" Thick Radial Tire String Repair
(Black) Self Vulcanizing U.S. Made
60 Repairs Per Box / 36 Boxes Per Case



TI755

Passenger String Tire Repair Kit
Includes: 5
0 Pcs ST1933US 4" Tire String,
1 Each of TI16 - Open Eye Needle,
TI16-N - Replacement Needle,
TI17 - Spiral Probe,
TI493 - Insertion Lube,
1 Razor Knife And Repair Booklet
In Molded Case



Universal String Insert

- For Use In Radial And Bias Ply Tires
 - Temporary Repairs Sealing By Compression Only
- **String Repair Should Be Considered and EMERGENCY Repair Solution When A Full Service Repair Facility Is Not Available. NOT Recommended For On The Wheel Tire Repairing**

Combination Repairs

TI601 Quill Seal Patch Plug, 1 3/4" Round, 3/16" Stem

TI602 Quill Seal Patch Plug, 1 7/8" Round, 1/4" Stem

TI603 Quill Seal Patch Plug, 2 1/4" Round, 5/16" Stem

QUICK AND
EASY
INSTALLATION

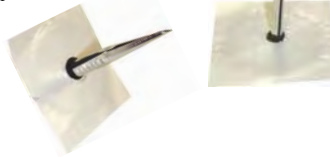

TI660 Lead Wire Combination 1" Round, 1/8" Stem

TI661 Lead Wire Combination 1 3/4" Round, 1/4" Stem

TI662 Lead Wire Combination 2" Round, 5/16" Stem

TI663 Lead Wire Combination 2" Round, 3/8" Stem

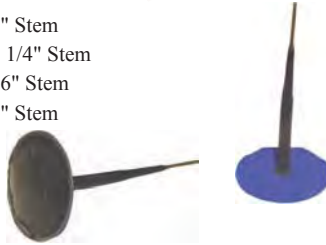

Universal Quill Seal Combination Repair

- For Use In Radial And Bias Ply Tires
- Designed For Chemical Vulcanization
- Black Vulcanizing Gum, White Backing
- Equipped With Metal Quill For Easy

Lead Wire Combination Repair

- For Use In Radial And Bias Ply Tires
 - Designed For Chemical Vulcanization
 - Patch Portion Has Gray Vulcanizing Gum With Blue Poly Backing
 - Stem Portion Is Dip Coated With Premium Vulcanizing Gum
- **No Special Tools Required: Use Carbide Cutter To Prepare The Injury, Install From The Inside, Pull Through, And Cut Off The Wire.**

Chemicals

TI210-6 Chemical Vulcanizing Cement, Flammable 8oz

TI232-6 Chemical Vulcanizing Cement, Flammable 32oz

TI240-6 Buffing Solution (Rubber Prep), Flammable 32oz

TI250-6 Bead Sealer, Flammable 32oz

TI241-6 Aerosol Buffing Solution (Rubber Prep), Non Flammable 16oz

TI245-6 Inner Liner Sealer, Non Flammable 16oz

TI235 Heavy Duty Vulcanizing Cement, Flammable 8oz
(Blue) Use With Hard Gum.

TI260 Aluminum Cement Can And Brush

TI265 Replacement Brush/Lid for Aluminum Cement Can



Tire Test Tanks

TI807 Tire Test Tank
Standard 31" x 12.75" x 12.75"



TI809 Large Test Tank
For Large Tires 35" x 15.50" x 17"



TIRE VALVES

Tubeless Snap-In Valves

- TR412 Snap-In Tire Valve, Height .88" - .453" Valve Hole
- TR413 Snap-In Tire Valve, Height 1.25" - .453" Valve Hole
- TR414 Snap-In Tire Valve, Height 1.50" - .453" Valve Hole
- TR415 Snap-In Tire Valve, Height 1.25" - .625" Valve Hole
- TR418 Snap-In Tire Valve, Height 2.00" - .453" Valve Hole
- TR423 Snap-In Tire Valve, Height 2.50" - .453" Valve Hole
- TR425 Snap-In Tire Valve, Height 2.00" - .625" Valve Hole



Tubeless Snap-In Valves - Chrome

- TR413CS Snap-In Tire Valve Height 1.25" - .453" Valve Hole
With Chrome Sleeve And Chrome Cap
- TR418CS Snap-In Tire Valve Height 2.00" - .453" Valve Hole
With Chrome Sleeve And Chrome Cap



High Pressure Snap-In Valves

- TR600HP High Pressure Snap-In Tire Valve, Height 1.27" - .453" Valve Hole
- TR602HP High Pressure Snap-In Tire Valve, Height 2.00" - .453" Valve Hole
- TR801HP High Pressure Snap-In Tire Valve, Height 1.31" - .625" Valve Hole
- TR802HP High Pressure Snap-In Tire Valve, Height 2.00" - .625" Valve Hole



Bolt-In Valves, Flush Mount

- 416 Nickel Plated Brass Tire Valve,
Height 1.44", .453" - .625" Valve Hole
- 416L Nickel Plated Brass Tire Valve,
Height 2.25", .453" - .625" Valve Hole



Brass Valves

- 500 Straight Brass Truck Valve, Height 2.00" - .625" Valve Hole
- 501 Straight Brass Truck Valve, Height 1.50" - .625" Valve Hole
- 501-Oval Oval Straight Brass Truck Valve, Height 1.50" - .625" Valve Hole
- 570 Straight Brass Truck Valve, Height 3.13" - .625" Valve Hole
- 571 Straight Brass Truck Valve, Height 3.38" - .625" Valve Hole
- 572 Straight Brass Truck Valve, Height 3.75" - .625" Valve Hole
- 573 Straight Brass Truck Valve, Height 4.38" - .625" Valve Hole
- 574 Straight Brass Truck Valve, Height 5.00" - .625" Valve Hole
- 575 Straight Brass Truck Valve, Height 1.13" - .625" Valve Hole



TIRE VALVES

Nickel Plated Brass Valves

- TR509** Nickel Plated Valves For Aluminum Rims Height .45" - Length 4.75" .625" Valve Hole; 90° Angle
- TR510** Nickel Plated Valves For Aluminum Rims Height .45" - Length 5.50" .625" Valve Hole; 90° Angle



Nickel Plated Brass Valves - Metric

- TR543D** Nickel Plated Brass Valves; Height 0.98" - 1.38" Length 9.7mm Valve Hole 60° Angle
- TR544D** Nickel Plated Brass Valves; Height 0.98" - 1.94" Length 9.7mm Valve Hole 60° Angle
- TR545D** Nickel Plated Brass Valves; Height 0.98" - 2.60" Length 9.7mm Valve Hole 60° Angle
- TR546D** Nickel Plated Brass Valves; Height 0.98" - 3.35" Length 9.7mm Valve Hole 60° Angle



Agricultural Valves, Air/Liquid

- TR618A** Tubeless Valve; Straight.
Recommended Torque At Installation: 45-75 in-lbs



Valve Extensions

- TI105-100** 3/4" Plastic Valve Extension (100 Per Box)
- TI107-100** 1 1/4" Plastic Valve Extension (100 Per Box)
- TI113** Metal Braided Dual Wheel Extension



Caps And Cores

For Standard Snap-In Tire Valves

- TI100** Plastic Tire Valve Cap (100 Per Box)
- TI100-500D** Plastic Tire Valve Cap (*500 Per Box*)



- TI103-100** Long Stainless Metal Dome Truck Cap, High Heat (100 Per Box)



- TI106** Green Plastic Cap (No O-Ring) (100 Per Box)



- TI171** High Heat Tire Valve Core (100 Per Box)
(*NOT FOR USE IN TPMS SENSORS*)



SOCKETS

TI1024D	1/2" Dr. x 3/4" Deep Socket	TI2026S	3/4" Dr. x 1-1/2" x 13/16" Square Socket
TI1034D	1/2" Dr. x 1-1/16" Deep Socket	TI2028D	3/4" Dr. x 7/8" Deep Socket
TI1036D	1/2" Dr. x 1-1/8" Deep Socket	TI2032D	3/4" Dr. x 1" Deep Socket
TI1017	1/2" Dr. x 17mm Std. Socket	TI2036DT	3/4" Dr. x 1-1/8" Deep Thinwall Socket
TI1017D	1/2" Dr. x 17mm Deep Socket	TI2038D	3/4" Dr. x 1-3/16" Deep Socket
TI1018	1/2" Dr. x 18mm Std. Socket	TI2030D	3/4" Dr. x 15/16" Deep Socket
TI1019	1/2" Dr. x 19mm Std. Socket	TI2040D	3/4" Dr. x 1-1/4" Deep Socket
TI1019DT	1/2" Dr. x 19mm Deep Thinwall Socket	TI3026S	1" Dr. x 13/16" Square Socket
TI1021	1/2" Dr. x 21mm Std. Socket	TI3033D	1" Dr. x 33mm Deep Socket
TI1021DT	1/2" Dr. x 21mm Deep Thinwall Socket	TI3321	1" Dr. x 41mm x 21mm Combination Socket
TI1022	1/2" Dr. x 22mm Deep Socket	TI3323	1" Dr. x 13/16" Sq. x 1-1/2" Hex Socket
TI1028D	1/2" Dr. x 7/8" Deep Socket	TI1246D	1/2" Dr. x 3/4" x 13/16" Deep Flip Socket
TI1028DT	1/2" Dr. x 7/8" Deep Thinwall Socket	TI1246DT	1/2" Dr. x 3/4" x 13/16" Deep Thinwall Flip Socket
TI1030D	1/2" Dr. x 15/16" Deep Socket	TI1291	1/2" Dr. x 19mm x 21mm Std. Flip Socket
TI1032D	1/2" Dr. x 1" Deep Socket	TI1291D	1/2" Dr. x 19mm x 21mm Deep Flip Socket
TI2034DT	3/4" Dr. x 1-1/16" Deep Thinwall Socket	TI1291DT	1/2" Dr. x 19mm x 21mm Deep Thinwall Flip Socket



TORQUE STICKS AND EXTENSIONS

TI5000 **9 Piece Wheel Torque Master Kit**
(Includes Sockets A, B, BB, C, E, F, G, I, Q)



TI6060 **5 Piece 1/2" Drive Wheel Torque Extension Kit**
Kit Includes Extensions: C, E, F, I and Q



Individual Sockets And Extensions Available Upon Special Request

WHEEL LOCK, LUGNUT AND HUB CAP REMOVAL KITS

TI1230 **Dual Sided Socket Lug Nut Removal Tool Kit**
 •**TI1240** - Tool For Chrysler And Dodge 21mm Chrome Cap Lugnuts
 •**TI1250** - Tool For GM And Chrysler 19mm Chrome Cap Lugnuts
 •**TI1260** - Tool For Dodge 22mm Chrome Cap Lugnuts
 •**TI1270** - Tool For Ranger Rover And Land Rover 27mm Chrome Cap Lugnuts
 Includes and Extractor Punch
 (Sockets Only)



TI4300 **3 Piece Twist Socket Lug Nut Removal Kit**
 For The Removal Of Damaged 3/4", 19mm, 13/16" And 21mm Lug Nuts. Sockets Are Dual Sided.
 Includes and Extractor Punch



TI4900 **Deluxe Hubcap And Wheel Lock Removal Kit**
 For The Removal Of Wire Wheel Hubcap Locks On 1978-1997 Vehicles. Removes Factory And Most Aftermarket Mag Wheel Locking Nut Locks. Also Includes Dual Sided (3/4" & 19mm, 13/16" and 21mm) Twist Socket Lugnut Remover.



TI220 **7/8" Black Nylon Lug Nut Cap**
 For Open-End Dual Threaded Acorn Lug Nuts



TI221 **3/4" Black Nylon Lug Nut Cap**
 For Open-End Dual Threaded Acorn Lug Nuts



TI222 **7/8" Chromed Nylon Lug Nut Cap**
 For Open-End Dual Threaded Acorn Lug Nuts



TI223 **3/4" Chromed Nylon Lug Nut Cap**
 For Open-End Dual Threaded Acorn Lug Nuts



WHEEL NUTS AND STUDS

OPEN-END ACORN LUG NUT		Thread Size	Hex	Height
TI181	Open-End Acorn Metric Chrome Lug Nut	12mm - 1.25	13/16"	.63"
TI182	Open-End Acorn Chrome Lug Nut	1/2" - 20	13/16"	.63"
TI183	Open-End Acorn Chrome Lug Nut	7/16" - 20	3/4"	.55"
TI184	Open-End Acorn Chrome Lug Nut	1/2" - 20	3/4"	.55"
TI185	Open-End Acorn Metric Chrome Lug Nut	12mm - 1.50	3/4"	.55"
TI186	Open-End Acorn Metric Chrome Lug Nut	12mm - 1.50	13/16"	.63"
TI187	Open-End Acorn Metric Chrome Lug Nut	12mm - 1.25	3/4"	.55"
1-PIECE ACORN LUG NUT		Thread Size	Hex	Height
TI300	1-Piece Acorn Chrome Lug Nut	1/4"	13/16"	1.43"
TI301	1-Piece Acorn Chrome Lug Nut	12mm - 1.25	13/16"	1.43"
TI302	Short 1-Piece Acorn Chrome Lug Nut	12mm - 1.25	13/16"	1.05"
TI303	1-Piece Acorn Chrome Lug Nut	12mm - 1.25	13/16"	1.43"
TI304	Short 1-Piece Acorn Chrome Lug Nut	12mm - 1.50	13/16"	1.05"
2-PIECE ACORN LUG NUT		Thread Size	Hex	Height
TI140	2-Piece Acorn Chrome Lug Nut	7/16"	13/16"	1.38"
TI141	2-Piece Acorn Chrome Lug Nut	1/2"	13/16"	1.38"
TI142	2-Piece Acorn Chrome Lug Nut	12mm - 1.25	13/16"	1.38"
TI143	2-Piece Acorn Chrome Lug Nut	12mm - 1.50	13/16"	1.38"
TI144	2-Piece Acorn Chrome Lug Nut	14mm - 1.50	13/16"	1.38"
TI305	2-Piece Acorn Chrome Lug Nut	12mm - 1.75	13/16"	1.40"
2-PIECE HIGH HEAT ACORN LUG NUT		Thread Size	Hex	Height
TI307	2-Piece High Heat Chrome Lug Nut	12mm - 1.25	13/16"	1.40"
TI308	2-Piece High Heat Chrome Lug Nut	12mm - 1.50	13/16"	1.40"
2-PIECE SHORT SHANK MAG CHROME LUG NUT		Thread Size	Hex	Height
TI157	2-Piece Short Shank Mag Chrome Lug Nut	7/16"	13/16"	1.45"
TI158	2-Piece Short Shank Mag Chrome Lug Nut	1/2"	13/16"	1.45"
TI159	2-Piece Short Shank Mag Chrome Lug Nut	12mm - 1.25	13/16"	1.45"
TI160	2-Piece Short Shank Mag Chrome Lug Nut	12mm - 1.50	13/16"	1.45"
BULGE STYLE ACORN LUG NUT		Thread Size	Hex	Height
TI145	Bulge Style Acorn Chrome Lug Nut	7/16"	3/4"	1.38"
TI146	Bulge Style Acorn Chrome Lug Nut	1/2"	3/4"	1.38"
TI147	Bulge Style Acorn Chrome Lug Nut	12mm - 1.25	3/4"	1.38"
TI148	Bulge Style Acorn Chrome Lug Nut	12mm - 1.50	3/4"	1.38"
TI149	Bulge Style Acorn Chrome Lug Nut	14mm - 1.50	3/4"	1.38"
TI150	Bulge Style Acorn Chrome Lug Nut	12mm - 1.75	3/4"	1.38"
TI310	Bulge Style Acorn Chrome Lug Nut	12mm - 1.50	3/4"	1.01"
TI151	Long Bulge Style Acorn Chrome Lug Nut	1/2"	13/16"	1.75"
TI152	Long Bulge Style Acorn Chrome Lug Nut	12mm - 1.50	13/16"	1.75"
TI153	Long Bulge Style Acorn Chrome Lug Nut	12mm - 1.75	13/16"	1.75"
TI154	Long Bulge Style Acorn Chrome Lug Nut	14mm - 1.50	13/16"	1.75"
TI155	Long Bulge Style Acorn Chrome Lug Nut	14mm - 2.00	13/16"	1.75"
TI156	Long Bulge Style Acorn Chrome Lug Nut	9/16"	13/16"	1.75"
TI161	Long Bulge Style Acorn Chrome Lug Nut	1/2"	3/4"	1.75"
TI162	Long Bulge Style Acorn Chrome Lug Nut	12mm - 1.50	3/4"	1.75"
TI163	Long Bulge Style Acorn Chrome Lug Nut	14mm - 1.50	3/4"	1.75"
TI164	Long Bulge Style Acorn Chrome Lug Nut	9/16" - 18	3/4"	1.75"
TI165	Long Bulge Style Acorn Chrome Lug Nut	12mm - 1.75	3/4"	1.75"
TI166	Long Bulge Style Acorn Chrome Lug Nut	14mm - 2.00	3/4"	1.75"
TI171	XL Long Bulge Style Acorn Chrome Lug Nut	14mm - 1.50	3/4"	1.90"
TI172	XL Long Bulge Style Acorn Chrome Lug Nut	9/16"	3/4"	1.90"
TI173	XL Long Bulge Style Acorn Chrome Lug Nut	14mm - 2.00	3/4"	1.90"
TI168	XX Long Bulge Style Acorn Chrome Lug Nut	14mm - 1.50	3/4"	2.32"
TI169	XX Long Bulge Style Acorn Chrome Lug Nut	14mm - 2.00	3/4"	2.32"
TI170	XX Long Bulge Style Acorn Chrome Lug Nut	9/16"	3/4"	2.32"
TI306	O.E. Bulge Style Acorn Chrome Lug Nut	14mm - 2.00	13/16"	1.00"



DUAL THREAD ACORN LUG NUT

TI312	O.E. Dual Thread Acorn Lug Nut 1	2mm - 1.5, 3/4" Hex, 24mm x 2 Outer Thread		
-------	----------------------------------	--	--	--

WHEEL STUDS		Thread Size	Height
TI190	Wheel Stud	12mm - 1.50	1.50"
TI191	Wheel Stud	12mm - 1.50	1.75"
TI192	Wheel Stud	12mm - 1.50	2.25"
TI193	Wheel Stud	1/2" / 14 - 1.50	1.50"
TI194	Wheel Stud	1/2" / 14 - 1.50	1.75"



Brass Fittings

- BF20** 1/4" Inverted Tube Union Brass Fitting
- BF25** 3/16" Inverted Tube Union Brass Fitting
- BF35** 3/16" Solderless Compression Union Brass Fitting



Cotter Pins

- MI30** 1/8" x 2" Unplated Cotter Pins (100 Per Bag) 
- MI35** 1/8" x 1 1/2" Unplated Cotter (100 Per Bag)

License Plate Nuts, Bolts And Screws

- MI110** License Plate Regular Point Bolt (100 Per Bag) 
- MI111** License Plate Nylon Nut (100 Per Bag) 
- MI116** License Plate Screw 1/2" O.D. Washer Head Slotted Bright Zinc Finish 1/4" (#14) x 3/4", 3/8" Indented Hex (100 Per Bag) 
- MI117** License Plate Screw Slotted Truss Head Zinc Plated 1/4" (#14) X 3/4", 9/16" Head Diameter (100 Per Bag) 
- MI114** License Plare Screw M6-1.0x20mm, 13mm Slotted washer Head, 10mm Hex 

Window Gear Dog Points

- MI96-30** Replacement Ford Dog Points For MI 95 Gear (30 Per Bag) 

Hose Clamps

Mini

- HCM-4E** 7/32" To 5/8" Mini Hose Clamp - Ventilated #4 Stainless Steel Band / Zinc Plated Housing (10 Per Box)
- HCM-6E** 7/16" To 25/32" Mini Hose Clamp - Ventilated #6 Stainless Steel Band / Zinc Plated Housing (10 Per Box)



Standard

- HC2-6E** 7/16" To 25/32" Standard Hose Clamp - Ventilated #6 Stainless Steel Band / Zinc Plated Housing (10 Per Box)
- HC2-8E** 1/2" To 29/32" Standard Hose Clamp - Ventilated #8 Stainless Steel Band / Zinc Plated Housing (10 Per Box)
- HC2-10E** 9/16" To 1 1/16" Standard Hose Clamp - Ventilated #10 Stainless Steel Band / Zinc Plated Housing (10 Per Box)
- HC2-12E** 11/16" To 1 1/4" Standard Hose Clamp - Ventilated #12 Stainless Steel Band / Zinc Plated Housing (10 Per Box)
- HC2-16E** 13/16" To 1 1/2" Standard Hose Clamp - Ventilated #16 Stainless Steel Band / Zinc Plated Housing (10 Per Box)

Premium Standard

- HC3-6P** 7/16" To 25/32" Premium Standard Hose Clamp #6 Ventilated Stainless Steel Band / Stainless Steel Housing (10 Per Box)
- HC3-8P** 1/2" To 29/32" Premium Standard Hose Clamp #8 Ventilated Stainless Steel Band / Stainless Steel Housing (10 Per Box)
- HC3-10P** 9/16" To 1 1/16" Premium Standard Hose Clamp #10 Ventilated Stainless Steel Band / Stainless Steel Housing (10 Per Box)
- HC3-12P** 11/16" To 1 1/4" Premium Standard Hose Clamp #12 Ventilated Stainless Steel Band / Stainless Steel Housing (10 Per Box)
- HC2-20E** 13/16" To 1 3/4" Standard Hose Clamp - Ventilated #20 Stainless Steel Band / Zinc Plated Housing (10 Per Box)
- HC2-24E** 1 1/16" To 2" Standard Hose Clamp - Ventilated #24 Stainless Steel Band / Zinc Plated Housing (10 Per Box)
- HC2-28E** 1 5/16" To 2 1/4" Standard Hose Clamp - Ventilated #28 Stainless Steel Band / Zinc Plated Housing (10 Per Box)
- HC2-32E** 1 9/16" To 2 1/2" Standard Hose Clamp - Ventilated #32 Stainless Steel Band / Zinc Plated Housing (10 Per Box)
- HC2-36E** 1 13/16" To 2 3/4" Standard Hose Clamp - Ventilated #36 Stainless Steel Band / Zinc Plated Housing (10 Per Box)

Fuel Injections

- HC1** 1/4" Fuel Injection Hose Clamp (Stainless Steel) #12 Solid Band, Not Ventilated (100 Per Bag)
- HC5** 5/16" Fuel Injection Hose Clamp (Stainless Steel) #14 Solid Band, Not Ventilated (100 Per Bag)
- HC10** 3/8" Fuel Injection Hose Clamp (Stainless Steel) #15 Solid Band, Not Ventilated (100 Per Bag)



- HC800** Hose Clamp Rack (26" x 24" x 6.5") 6 lbs. Empty, Includes Hooks



Peel Rivets

PR6175 Short Aluminum Window Regulator Peel Rivet, Steel Mandrel
1/4" Hole Size, Panel Range 1/32" - 9/64", Flange Size 1/2",
GM # 9436175 (100 Per Bag)



PR7938 Long Aluminum Glass Stop Peel Rivet, Steel Mandrel
1/4" Hole Size, 33/64" - 19/32" Panel Range, 1/2" Flange Size
GM # 9437938 (100 Per Bag)



Universal Retainers

MI602 Black Universal Nylon Shield Retainer Head Diameter 23/64",
Stem Diameter 3/16", Stem Length 7/16" GM # 10063599 (100 Per Bag)

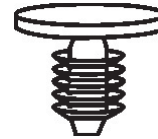

MI603 Black Universal Nylon Weather-Strip Retainer Head Diameter 7/16",
Shaft Diameter 7/32", Stem Length 5/16", GM # 10169777 (100 Per Bag)

MI604 Black Universal Nylon Weather-Strip Retainer Head Diameter 3/8",
Stem Diameter 7/32", Stem Length 3/8" GM # 2964547 (100 Per Bag)

MI605 Black Universal Nylon Dash Panel Retainer Head Diameter 7/16",
Stem Diameter 3/16", Stem Length 5/8" GM # 25016383 (100 Per Bag)

MI606 Black Nylon Screen Shroud Vent Grille To Panel Retainer Head Diameter 19/32",
Stem Diameter 7/32", Stem Length 3/4" GM # 20514862 (100 Per Bag)

MI607 Black Universal Nylon Trim Panel Retainer Head Diameter 1",
Stem Diameter 9/32", Stem Length 1-1/16" Ford # 388930-S (100 Per Bag)

MI608 Black Universal Nylon Weather-Strip Retainer Head Diameter 10mm,
Stem Diameter 6mm, Stem Length 12mm GM # 20699808 (100 Per Bag)

MI609 Black Universal Nylon Weather-Strip Retainer Head Diameter 3/8",
Stem Diameter 7/32", Stem Length 5/8" Chrysler # 4658673 (100 Per Bag)

MI610 Black Universal Nylon Shield Retainer Head Diameter 1",
Stem Diameter 1/4", Stem Length 25/32" Ford # N808370-S (100 Per Bag)

MI611 Black Universal Nylon Trim Panel / Bumper Filler Retainer Head Diameter 1/2",
Stem Diameter 9/32", Stem Length 3/4" GM # 411700 (100 Per Bag)

MI612 Black Universal Nylon Shield Retainer Head Diameter 11/16",
Stem Diameter 5/16", Stem Length 5/8" GM # 332364 (100 Per Bag)

MI613 Black Universal Nylon Hood Seal Retainer Head Diameter 3/4",
Stem Diameter 5/16", Stem Length 1-3/8" GM # 14074081 (100 Per Bag)

MI614 Black Universal Nylon Shield Retainer Head Diameter 11/16",
Stem Diameter 5/16", Stem Length 13/16" GM # 1605396 (100 Per Bag)

MI615 Black Universal Nylon Shield Retainer Head Diameter 11/16",
Stem Diameter 5/16", Stem Length 1-1/16" GM # 10121502 (100 Per Bag)

MI616 Black Universal Nylon Fascia Panel Retainer Head Diameter 25mm,
Stem Diameter 7.5mm, Stem Length 20mm Chrysler # 6501067 (100 Per Bag)

MI617 Black Universal Nylon Shield Retainer Head Diameter 1",
Stem Diameter 19/64", Stem Length 1-1/16" Chrysler # 6502104 (100 Per Bag)

MI618 Black Universal Nylon Bumper Fascia Retainer Head Diameter 3/4",
Stem Diameter 11/32", Stem Length 1-3/16" GM # 10185925 (100 Per Bag)

MI619 Black Universal Nylon Textured Head Panel Retainer Head Diameter 26mm,
Stem Diameter 8mm, Stem Length 38mm Ford # E7EB5802354AAJABH (100 Per Bag)

MI620 Black Universal Nylon Panel Retainer 5/16" (7.8mm) Hole Size,
.080" - .270" Panel Range Chrysler # 34202335 (100 Per Bag)

MI621 Black Universal Nylon Hood Seal Retainer Head Diameter 3/4",
Stem Diameter 11/32", Stem Length 7/8" GM # 21094146 (100 Per Bag)

MI622 Black Universal Nylon Trim Panel Retainer Head Diameter 5/8",
Stem Diameter 3/8", Stem Length 3/4" Ford # N807721-S (100 Per Bag)

MI623 Black Universal Nylon Panel Retainer Head Diameter 1",
Stem Diameter 7/16", Stem Length 13/16" GM # 1619321 (100 Per Bag)

MI624 Black Universal Nylon Fascia Bumper Retainer Head Diameter 22mm,
Stem Diameter 11mm, Stem Length 28mm Ford # N804379S (100 Per Bag)

ASSORTMENTS

OPK450 Air Conditioning Deluxe HNBR O-Ring Kit (350 Pcs)



OPK2005 Professional Air Conditioning Assortment (700 Pcs)



DP800 Large Drain Plug And Gasket Assortment (162 Pcs)



DP600 Drain Plug Assortment For Newer Car Applications (114 Pcs)



OPK23 Universal Nylon Retainer Assortment (311 Pcs)



OPK38 Universal Rivet Assortment (263 Pcs)



OPK10 Giant Black Automotive O-Ring Assortment (382 Pcs)



OPK67 Chrome Lug Nut Assortment (52 Pcs)



We Carry A Wide Range Of Assortments

- Air Conditioning Assortments ▪ Brake Hardware Assortments
- Drain Plug And Gasket Assortments ▪Fuses Assortments
- Retainer And Rivet Assortments ▪Solderless Terminal / Electrical Assortments
- Tire Hardware Assortments ▪Vacuum Cap, Connector And Tee Assortments

ASSORTMENTS

OPK12 Rubber Vacuum Cap Assortment (90 Pcs)



OPK2000 Large Vacuum Tee, Cap And Connector Assortment (385 Pcs)



OPK335 Fuel Line Retainer Clip Assortment (32 Pcs)



OPK210 Cotter Pin Assortment (1000 Pcs)



OPK640 Low Profile Mini Fuse Assortment (30 Pcs)



OPK400 Combo ATC/ATO, Mini And Maxi Fuse Assortment (218 Pcs)



OPK940 Large Solderless Terminal Assortment (940 Pcs)



OPK57 Heat Shrink Tubing Dual Wall / Meltable Inner Wall Assortment (28 Pcs)



DRAIN PLUGS AND GASKETS

Drain Plug Gaskets

DP7167 14mm Aluminum Gasket Hyundai



DP7101S Aluminum Gasket 14mm Dead Soft



DP7501 Fiber Gasket 14mm



DP7525 Fiber Gasket 12mm



DP7409 Metal And Rubber Ford Gasket 14mm (Blue) O.E. #F3DZ-6734A"



DP7408 Metal And Rubber GM Gasket 12mm (Black) O.E. #14090908, 24571185



DP7000 Metal And Rubber Gasket 12mm Crimped, (Brown)



DP4800 Oil Drain Plug Removal Twist Socket Removal Kit
Easily Removes Damaged Oil Drain Plugs
Kit Includes: 7 Sockets; 13mm, 15mm, 16mm, 17mm
19mm x 3/4", 9/16", 22mm (comes with mounting rack)



Drain Plugs

DP7701 14mm - 1.50 Drain Plug Regular Point Plain Finish



DP7715 1/2" - 20 Dog Drain Plug Point Plain Finish



DP7725 12mm - 1.75 Dog Drain Plug Point Zinc Plate



DP7802 14mm - 1.50 Drain Plug Dog Point Zinc Plate 16mm Hex



DP7846 14mm - 1.50, 17mm Hex Drain Plug Honda O.E. #90009-PH1-000



DP8006 14mm - 1.50 (13mm Hex Head) Drain Plug With Inset Rubber Gasket 4.0L Ford O.E. #F6TZ-6730BA



DP8007 14mm - 1.50 (16mm Hex Head) Drain Plug With Inset Rubber Gasket



DP8008K 14mm x 1.50 Drain Plug With O-Ring For Cadillac Catera. Replaces Cadillac O.E.# 90502556



DP8022 14mm-1.50 Drain Plug Honda OE Style Long Version Ford 6.8L O.E. #F75Z-6730BAA



DP8026 14mm - 1.50 Drain Plug With Inset Rubber Gasket. Chrysler OE # 6507741AA



DP8031 12mm x 1.75 Drain Plug With Inset Rubber Gasket GM# 11562588 - 15mm Hex



DP8031M Magnetic 12mm x 1.75 Drain Plug With Inset Rubber Gasket 15mm Hex GM# 11562588



FUEL FILTERS

TMR #	AC Delco	Fram	Wix	Description
GF481	GF481	-	33481	Gas Filter - GM Cutlass, Celebrity, Century Eurosport 1989-1991
GF800	FG800	3802	33097	Gas Filter - Ford Escort, Tracer, Sable, Mustang And Lincoln 1983 And Up (With Clips)
GF580	GF580	7333	33484	Gas Filter - GM Cadillac 1991-1994, Cutlass 87-88
GF645	GF645	8219	33579	Gas Filter - Chevy / GMC / Oldsmobile / Isuzu 1997-2005
GF827	GF827	CS9864	-	Diesel Filter-Ford Turbo Diesel 6.0L
GF861	GF864	CS8941	-	Diesel Filter-Dodge 5.9L 2000-2002, For Cummins ISB 2000-2004
GF863	FGF863	CS8323	-	Diesel Filter-Dodge Turbo 5.9L 1997-1999
GF986	-	-	-	Gas Filter - Ford 1998-2000
GF4777	GF600	4777	33023	Gas Filter - Infiniti 1990-2004, Isuzu 1988-1995, Mercury 1999-2001, Nissan 1984-2009
FD4596	GF862	CS8629	33818	Diesel Filter - Ford Light Truck V8 7.3L Diesel 1999-2003
FD4604	GF691	CS9667	33899	Diesel Filter - Ford Light Truck V8 6.0L Diesel 2003-2006
TP1256	TP1256	PS7358	33376	Diesel Filter - Paper Cartridge Filter GM All Trucks And SUV's V8 6.5L 395 CID 1992-2002, AM General Hummer H1, V8 6.5L 395CID Diesel 1994-2001, V8 6.2L 379 CID Diesel 1992-1994, V8 5.7L 350 CID Gas
TP1263	TP1263	PS8622	-	Diesel Filter-GM 6.5L 1996-2003
TP1297	TP1297	CS7715	-	Diesel Filter-Ford 7.3L 1995-1998
TP1298	TP1298	PS9059A	-	Diesel Filter-Chevy-GM Duramax 6.6L 2001-2009



Steel Fuel Line Repair Kits

GLR360 Steel Fuel Line Repair Kit 3/8" x 9" Line, 16 mm Fittings



GLR5169 Steel Fuel Line Repair Kit 5/16" x 9" Line, 14 mm Fittings



FRL3487K Steel Fuel Line Repair Kit Toyota - Steel 5/16" x 8 3/4" - 14mm Fitting



FRL3175 Steel Fuel Line Repair Kit GM, Chrysler 3/8" Connector To 10mm - 4" Nylon Line



360° Flexible Nylon OEM Fuel Repair Lines

FRL3085K Universal 12 - 8mm - 5/16" Nylon Fuel Repair Splice 10" Nylon Line



FRL3086K Universal 12 - 10mm - 3/8" Nylon Fuel Repair Splice 10" Nylon Line



FRL3100K GM, Chrysler - 3/8" Connector To 10mm 10" Nylon Line



FRL3101K GM, Chrysler - 5/16" Connector to 8mm - 5/16" 10" Nylon Line



FRL3154K GM, Chrysler - 3/8" Connector Elbow To 10mm 10" Nylon Line



Many Other Filters And Repair Lines Available

AIR CONDITIONING

O-Rings

AC35 Green # 6 Hose Fitting O-Ring (3/8")



AC45 Green #10 Hose Fitting O-Ring (5/8")



AC40 Green #8 Hose Fitting O-Ring (1/2")

AC50 Green #12 Hose Fitting O-Ring (3/4")

Orifice Tubes

AC1 GM White Orifice Tube



AC5 Ford Blue Orifice Tube



AC15 Ford Green Orifice Tube



AC25 GM Black And White Orifice Tube



Retrofitting Parts

AC160 Straight High Side Aluminum Retrofit Fitting
3/8" - 24 Thread With Red M8 x 1 Cap



AC165 Straight Low Side Aluminum Retrofit Fitting
7/16" - 20 Thread With Blue M8 x 1 Cap



AC123-100 Standard Air Conditioning Valve Core (100 Per Box)



Service Tools

AC2500 Manual Service Coupler R134a High Side (Red) 6 Bearings



AC5500 Manual Service Coupler R134a Low Side (Blue) 6 Bearings



Charging Hoses

AC2200 96" R134a Red Charging Hose 14mm-M x 1/2" ACME-F



AC5200 96" R134a Blue Charging Hose 14mm-M x 1/2" ACME-F



Recycling Filters

AC34430 Quick Change Recycling Filter For Robinair Models



AC34724 Spin On Recycling Filter For Robinair Models



AC80069 Short High Side Filter Drier (Outlet Filter)
For 1996-2000 RTI Recycling Machines.



AC80077 Long Low Side Filter Drier (Inlet Filter)
For 1996-2000 RTI Recycling Machines.



Air Conditioning Fluids

AC 32-32 ESTER WITH UV Dye -Quart. (12 Per Case)

AC 32-8 ESTER WITH UV Dye -8oz. (12 Per Case)

AC 4100 U/V Leak Detection Dye -1/4 oz. (12 Per Case)



BRAKE COILS, LINES & FITTINGS

Poly Vinyl Fluoride Brake Line Coils

- BL3316 Poly Vinyl Fluoride 3/16" X 25' Brake Line Coil
- BL3414 Poly Vinyl Fluoride 1/4" x 25' Brake Line Coil
- BL3516 Poly Vinyl Fluoride 5/16" x 25' Brake Line Coil
- BL3638 Poly Vinyl Fluoride 3/8" x 25' Brake Line Coil



Cupro Nickel Brake Line Coils

- BL6316 Cupro Nickel 3/16" x 25' Brake Line Coil
- BL6338 Cupro Nickel 3/8" x 25' Brake Line Coil
- BL6414 Cupro Nickel 1/4" x 25' Brake Line Coil
- BL6516 Cupro Nickel 5/16" x 25' Brake Line Coil
- BL8316 Cupro Nickel 3/16" x 100' Brake Coil
- BL8416 Cupro Nickel 1/4" x 100' Brake Coil



Standard Zinc Brake Line Coils

- BL7316 Standard Zinc 3/16 x 25' Brake Line Coil
- BL7414 Standard Zinc 1/4" x 25' Brake Line Coil
- BL7516 Standard Zinc 5/16" x 25' Brake Line Coil
- BL7636 Standard Zinc 3/8" x 25' Brake Line Coil
- BL7706 Standard Zinc 6mm x 25' Brake Line Coil



Standard Zinc Brake Lines

- BL9308 Standard Zinc 3/16 x 8" Brake Line
- BL9312 Standard Zinc 3/16 x 12" Brake Line
- BL9320 Standard Zinc 3/16 x 20" Brake Line
- BL9330 Standard Zinc 3/16 x 30" Brake Line
- BL9340 Standard Zinc 3/16 x 40" Brake Line
- BL9351 Standard Zinc 3/16 x 51" Brake Line
- BL9360 Standard Zinc 3/16 x 60" Brake Line
- BL9372 Standard Zinc 3/16 x 72" Brake Line
- BL9408 Standard Zinc 1/4 x 8" Brake Line
- BL9412 Standard Zinc 1/4 x 12" Brake Line
- BL9420 Standard Zinc 1/4 x 20" Brake Line
- BL9430 Standard Zinc 1/4 x 30" Brake Line
- BL9440 Standard Zinc 1/4 x 40" Brake Line
- BL9451 Standard Zinc 1/4 x 51" Brake Line
- BL9460 Standard Zinc 1/4 x 60" Brake Line
- BL9472 Standard Zinc 1/4 x 72" Brake Line
- BL9508 Standard Zinc 5/16 x 8" Brake Line
- BL9512 Standard Zinc 5/16 x 12" Brake Line
- BL9520 Standard Zinc 5/16 x 20" Brake Line
- BL9530 Standard Zinc 5/16 x 30" Brake Line
- BL9540 Standard Zinc 5/16 x 40" Brake Line
- BL9551 Standard Zinc 5/16 x 51" Brake Line
- BL9560 Standard Zinc 5/16 x 60" Brake Line
- BL9572 Standard Zinc 5/16 x 72" Brake Line
- BL9608 Standard Zinc 3/8 x 8" Brake Line
- BL9612 Standard Zinc 3/8 x 12" Brake Line
- BL9620 Standard Zinc 3/8 x 20" Brake Line
- BL9630 Standard Zinc 3/8 x 30" Brake Line
- BL9640 Standard Zinc 3/8 x 40" Brake Line
- BL9651 Standard Zinc 3/8 x 51" Brake Line
- BL9660 Standard Zinc 3/8 x 60" Brake Line
- BL9672 Standard Zinc 3/8 x 72" Brake Line



Brake Line Fitting Assortments

- OPK1245 Brass Brake Line Adaptor Assortment
Standard - Metric - Bubble - Invert
2 Boxes / 52 Adaptors



- OPK1266 Standard And Metric Tube Nut And Union Assortment
2 Boxes / 52 Adaptors



*Individual
Brake Line Fittings
Available*

Brake Line Tools

- BL5403 Invert/Standard Flaring Tool
3/16" - 1/4" - 5/16" - 3/8"



- BL5405 Bubble / ISO Flaring Tool
4.75 (3/16") - 6mm (1/4") 8mm-10mm



- BL5415 Heavy Duty Brake Line Tube Bender
3/16"-6mm - 1/4"



- BL5406 Small Ratcheting Tube Cutter
1/8" - 1/2" (6-23mm) OD Tube

- BL5407 Large Ratcheting Tube Cutter
1/4" - 7/8" OD Tube



- BL5416 Heavy Duty Tube Bender
Adapts To Make Even The Most
Bends Simple And Easy
3/16" - 1/4" - 5/16" - 3/8" - 6mm-8mm-10mm



ELECTRICAL

Bulbs

Halogen Bulbs

BU9004	9004 Halogen Bulb 12 Volt, 45 Watt - Greenlite Brand
BU9005	9005 Halogen Bulb 12 Volt, 65 Watt - Greenlite Brand
BU9006	9006 Halogen Bulb 12 Volt, 55 Watt - Greenlite Brand
BU9007	9007 Halogen Bulb 12 Volt, 65/55 Watt - Greenlite Brand
BUH1	H1 Halogen Bulb 55 Watt – 12 Volt



BUH4-60	H4 Halogen Bulb 60 / 55 Watt – 12 Volt (Same As 9003)
BUH7	H7 Halogen 55 Watt - 12 Volt - Import Brand
BUH8	H8 Halogen 35 Watt
BUH9	H9 Halogen 65 Watt
BUH10	H10 Halogen / 9145 45 Watt

Miniature Bulbs

BU194	Turn Marker Miniature Bulb (10 Per Box)
BU912	Third Light Miniature Bulb (10 Per Box)
BU921	Third Brake Light And Dome Miniature Bulb 18 Watt, 1.4 amp, 12.8 Volt (10 Per Box)
BU1156	Front Turn Miniature Bulb (10 Per Box)
BU1157	Stop And Turn Miniature Bulb (10 Per Box)
BU3057	Stop And Turn Miniature Bulb U.S. Made - Wagner (10 Per Box)
BUIMP3057	Stop And Turn Miniature Bulb U.S. Made - Dynabrite (10 Per Box)
BU3157	Stop And Turn Miniature Bulb U.S. Made - Wagner (10 Per Box)
BUIMP3157	Stop And Turn Miniature Bulb U.S. Made - Dynabrite (10 Per Box)
BU3157NA	Turn And Park Miniature Bulb U.S. Made - Wagner (10 Per Box)
BUIMP3157NA	Turn And Park Miniature Bulb U.S. Made - Dynabrite (10 Per Box)
BUIMP3757NA	Long Life - Sylvania Brand Bulb 12V 26.9/8.3W S8 Wedge Amber Amber Signal-Parking And Front Turn Signal-GM (10 Per Box)
BH4157K	Krypton Gas Filled, Sylvania Branded Bulbs
BU7443	Tail Miniature Bulb (10 Per Box)



Miniature Bulbs For European Cars

BU17125	Dome, Glove Box And License Tag Double Ended Festoon Lamp 12V : 5 Watt : SV8.5 Base
BU17171	Front Marker, Front Parking 12V : 5 Watt : BA15s Base
BU17635	Front And Rear Turn Signal, Rear Tail, Clear, Most Popular European Turn Signal 12V : 21 Watt : BA15s Base
BU17881	Clear Stop, Tail, Newer European Cars 12V : 21/4 Watt : BAZ15d Base



Cable Ties

BL4	Black Cable Tie 4" 18 lb. (100 Per Bag)
BL6	Black Cable Tie 6" 40 lb. (100 Per Bag)
BL8	Black Cable Tie 8" 50 lb. (100 Per Bag)
BL8-18	Black Thin Cable Tie 8" 18 lb. (100 Per Bag)
BL8W	Black Wide Cable Tie 8" 120 lb. (100 Per Bag)
BL11	Black Cable Tie 11" 50 lb. (100 Per Bag)
BL14	Black Cable Tie 14" 50 lb. (100 Per Bag)
BL14MT	Black Mounting Cable Tie 14" 50 lb. (100 Per Bag)
BL14W	Black Wide Cable Tie 14" 120 lb. (100 Per Bag)
BL17W	Black Extra Wide Cable Tie 17" 175 lb. (100 Per Bag)
BL24	Black Extra Wide Cable Tie 24" 175 lb. (50 Per Bag)
BL36	Black Extra Wide Cable Tie 36" 175 lb. (50 Per Bag)
BL48	Black Extra Wide Cable Tie 48" 175 lb. (50 Per Bag)



CL4	Natural Cable Tie 4" 18 lb. (100 Per Bag)
CL6	Natural Cable Tie 6" 40 lb. (100 Per Bag)
CL8	Natural Cable Tie 8" 50 lb. (100 Per Bag)
CL11	Natural Cable Tie 11" 50 lb. (100 Per Bag)
CL14	Natural Cable Tie 14" 50 lb. (100 Per Bag)
CL14W	Natural Wide Cable Tie 14" 120 lb. (100 Per Bag)
CL17W	Natural Extra Wide Cable Tie 17" 175 lb. (100 Per Bag)
CL24	Natural Cable Tie 24" 175 lb. (50 Per Bag)
CL36	Natural Cable Tie 36" 175 lb. (50 Per Bag)



ELECTRICAL

Fuses

ATC Fuses

FUATC10-100	ATC / ATO 10 Amp Blade Fuse
FUATC15-100	ATC / ATO 15 Amp Blade Fuse
FUATC20-100	ATC / ATO 20 Amp Blade Fuse
FUATC25-100	ATC / ATO 25 Amp Blade Fuse
FUATC30-100	ATC / ATO 30 Amp Blade Fuse



ATM Fuses

FUATM10-100	Mini 10 Amp Fuse Red
FUATM15-100	Mini 15 Amp Fuse Blue
FUATM20-100	Mini 20 Amp Fuse Yellow
FUATM25-100	Mini 25 Amp Fuse Tan
FUATM30-100	Mini 30 Amp Fuse Green



Low Profile Mini Blade Fuses

FU08907.5-10	Low Profile Mini 7.5 Amp Blade Fuse Brown
FU089010-10	Low Profile Mini 10 Amp Blade Fuse Red
FU089015-10	Low Profile Mini 15 Amp Blade Fuse Blue



FU089020-10	Low Profile Mini 20 Amp Blade Fuse Yellow
FU089025-10	Low Profile Mini 25 Amp Blade Fuse Natural
FU089030-10	Low Profile Mini 30 Amp Blade Fuse Green

Tape

EL20	Teflon Tape 1/2" x 260"
-------------	-------------------------



EL25	Electrical Tape 3/4" x 60 Yards-UL Listed (10 Rolls Per Sleeve)
-------------	---



Butt Connectors

BC1-100	Blue Vinyl Butt Connector (14-16)
BC5-100	Red Vinyl Butt Connector (16-22)
BC10-100	Yellow Vinyl Butt Connector (10-12)
HT20-100	Butt Connector With Heat Shrink Tubing Red (16-22)



Quick Disconnect

ST100-100	1/4" Female Fully Insulated Nylon Blue Quick Disconnect
ST120-100	1/4" Male Insulated Vinyl Blue Quick Disconnect
ST125-100	1/4" Female Insulated Vinyl Blue Quick Disconnect
ST130-100	1/4" Female Insulated Vinyl Yellow Quick Disconnect



Rings

STB8-100	#8 Blue Ring Vinyl Insulated (16-14)
STB10-100	#10 Blue Ring Vinyl Insulated (16-14)
STB14-100	1/4" Blue Ring Vinyl Insulated (16-14)
STNY10-100	#10 Nylon Yellow Ring (12-10)
STNY14-100	1/4" Nylon Yellow Ring (12-10)



STNY56-100	5/16" Nylon Yellow Ring (12-10)
STR14-100	1/4" Red Ring Vinyl Insulated (22-18)
STY10-100	#10 Yellow Ring Vinyl Insulated (12-10)
STY14-100	1/4" Yellow Ring Vinyl Insulated (12-10)
STY38-100	3/8" Yellow Ring Vinyl Insulated (12-10)

Spades

STRS10-100	#10 Red Spade Vinyl Insulated (22-18)
-------------------	---------------------------------------



Quick Splice

EL1-100	Blue Quick Splice Connector - Scotch Lock Type
EL5-100	Red Quick Splice Connector - Scotch Lock Type



EL10-100	Yellow Quick Splice Connector - Scotch Lock Type
EL15-100	White Quick Splice Connector - Scotch Lock Type

Single Blade T-Taps

ST505-100	Red Single Blade T-Tap (100 Per Bag)
ST510-100	Blue Single Blade T-Tap (100 Per Bag)



ST515-100	Yellow Single Blade T-Tap (100 Per Bag)
------------------	---

Heat Shrink Tubing Strips And Rolls

HT1-50	3" Red Heat Shrink Tubing Thin Wall - 1/8" (50 Per Bag)
HT5-50	3" Blue Heat Shrink Tubing Thin Wall - 1/4" (50 Per Bag)
HT10-50	3" Yellow Heat Shrink Tubing Thin Wall - 5/16" (50 Per Bag)



HTR1-10	10' Roll Red Heat Shrink Tubing Thin Wall - 1/8"
HTR1-50	50' Roll Red Heat Shrink Tubing Thin Wall - 1/8"
HTR5-10	10' Roll Blue Heat Shrink Tubing Thin Wall - 1/4"



SHOP SUPPLIES

Bead Booster And Accessories

TC625A Automatic Bead Booster

- Automatic Valve
- Push Button Trigger Releases Air 20% Faster Than Manual Valve Bead Booster



TC658M Manual Bead Booster

- Manual Valve



- Double Barrel Disperses Air Evenly Around Wheel
- Safety Pop-Off Valve To Prevent Overloading
- ASME And CE Certified
- Powder Coated Inside and Outside Of Tank To Prevent Rust From Airline Moisture
- Works On All Light Truck, RV, Large Truck Tires
- Safety Goggle And Earplugs Included With Every Unit

TC620 Booster Upgrade Kit for Manual Bead Seater.

Upgrade An Awkward Manual Bead Seater Into An Efficient, Easy To Handle Automatic Booster.

Advantages Of Upgrading:

- Faster Air Release
- Quicker Air Release Means Less Air Pressure Needed
- Push Button Trigger Makes It Easy To Operate
- Double Barrel Disperses Air Evenly Around Wheel



Even Old Tanks That Are Working Can Be Upgraded

TC637 Bead Bazzoka™ Combines The Most Powerful Automatic Rapid Air Release System And The Easiest To Handle Tank For Seating Tubless Tire Beads.

- Light Weight (14 lbs.) Reduces Stress On Technician
- Push Button Trigger - Allows Technician To Keep <<Both Hands On The Tank>>
- Slotted Double Barrel Direct The Air For Best Overall Lift
- 150 PSI Pop-Off Valve



Jack Stands

TC603 3 Ton Capacity

Min Height: 10.55" • Max Height: 16.75"
Length: 7.50" • Width: 6.70"
Gross Weight 15 • Net Weight 14



TC612 12 Ton Capacity

Min Height: 17.30" • Max Height: 28.00"
Length: 12.20" • Width: 10.28"
Gross Weight 60 • Net Weight 58

TC606 6 Ton Capacity

Min Height: 15.50" • Max Height: 23.50"
Length: 10.65" • Width: 9.45"
Gross Weight 30 • Net Weight 28

Garage Jacks

TC670 3 Ton Garage Jack

Min Height: 4.15" • Max Height: 19.30"
Length: 31.30" • Width: 15.15"
Gross Weight 110 • Net Weight 107



TC682 20 Ton Bottle Jack

Min Height: 9.50" • Max Height: 18.60"
Hydr. Stroke: 5.90" • Ext. Screw 3.15"
Length: 5.90" • Width: 6.25"
Gross Weight 25 lbs. • Net Weight 23 lbs.



TC8000 Handle Grip "Protects Vehicles From Scratches And Dents"

TC8775 Fits Multiple Manufacturers Jack Handles
Made Of Durable Synthetic Rubber
TC8000 Black and TC8775 Safety Yellow

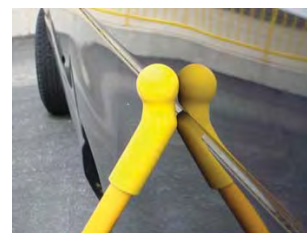

Tubeless Tire Demount Tool

TC600 2 Piece System That Mounts And Demounts All Standard 19.5" • 22.5" • 24.5" Tubeless Tires Up To 315/80R22.5, Including Those Mounted On Aluminum Wheels. It Is No Longer Necessary To Stand The Tire Up In Order To Dismount The Second Bead, The Process Can Be Mounted And Demounted On The Ground.



Great For Fleet Type Accounts
*** Semi Trucks



One Tool To Do All Jobs!

SHOP SUPPLIES

Bead Breakers

TC710 "Combi" Tire Bead Breaker



TC720 OTR Giant Tire Bead Breaker



Hydraulic Pumps

TC735 2.5 Quart Air / Hydraulic Pump (10,000 psi)
With High Density Polyethylene Reservoir

TC765 2.5 Quart Air / Hydraulic Pump (5,500 psi)
With High Density Polyethylene Reservoir

TC775 2.5 Quart Air / Hydraulic Pump (3,900 psi)
With High Density Polyethylene Reservoir"



TC750 Hydraulic Hose And Coupler
(8 Foot Hose, 10,000 PSI (700 bar)
With Hose Half Coupling.)



Tire Cages And Racks

TTC9400 4 Bar Safety Inflation Tire Cage
22" x 26" x 57" - 146 lbs.
Available In 2, 3, 4 And 5 Bars

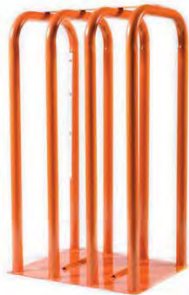

T19415 Tire Cart
Capacity 8 Tires (29" OD)
16" To 35" OD Max - 110 lbs.



T19000 Folding Rack
Capacity 32 To 60 Tires
72" x 50" x 66" - 205 lbs.



T19210 Stacking Rack
Capacity 28 To 35 Tires
60" x 60" x 60" - 115 lbs.



T19435 Tire Shelving
Capacity 30 To 36 Tires
92" x 92" x 18" - 110 lbs.



T19500 Wall Mount Tire Rack
Capacity 8 Tires
66" Wide - 52 lbs.



Spare Tire Removal Kit And Keys

T18435 Spare Tire Removal Kit - Kit Includes

- T18410 - Blue - Pin Head
- T18430 - Green 12mm Square Head
- T18460 - Black - Slotted Square Head
- T18400 - Red - Flat Head
- T18420 - Yellow- Hex Head
- T18440 - Orange - Std. Square Head
- T18480 - Purple - 3/8" Square Head
- (T18470 - Hanging Rack Included)



**Great Time
Saver**



ABRASIVES

Aluminum Oxide Disc - Sandpaper

MI215-100 2" Aluminum Oxide Disc - 36 Grit
(100 Per Box)

MI225-100 2" Aluminum Oxide Disc - 50 Grit
(100 Per Box)

MI235-100 2" Aluminum Oxide Disc - 80 Grit
(100 Per Box)

MI245-100 2" Aluminum Oxide Disc - 120 Grit
(100 Per Box)



MI315-100 3" Aluminum Oxide Disc - 36 Grit
(100 Per Box)

MI325-100 3" Aluminum Oxide Disc - 50 Grit
(100 Per Box)

MI335-100 3" Aluminum Oxide Disc - 80 Grit
(100 Per Box)

MI345-100 3" Aluminum Oxide Disc - 120 Grit
(100 Per Box)

Surface Conditioning Discs - Resin Fiber

MI197-100 2" Surface Conditioning Disc Coarse Grit
(Brown) (100 Per Box)

MI297-100 2" Surface Conditioning Disc Medium Grit
(Maroon) (100 Per Box)

MI397-100 2" Surface Conditioning Disc Fine Grit
(Blue) (100 Per Box)



MI17-100 3" Surface Conditioning Disc Coarse Grit
(Brown)(100 Per Box)

MI27-100 3" Surface Conditioning Disc Medium Grit
(Maroon) (100 Per Box)

MI37-100 3" Surface Conditioning Disc Fine Grit
(Blue) (100 Per Box)

Blue Zirconia Discs

MI202-50 2" Blue Zirconia Disc - 24 Grit (50 Per Box)

MI203-50 2" Blue Zirconia Disc - 36 Grit (50 Per Box)

MI204-50 2" Blue Zirconia Disc - 50 Grit (50 Per Box)



MI302-25 3" Blue Zirconia Disc - 24 Grit (25 Per Box)

MI303-25 3" Blue Zirconia Disc - 36 Grit (25 Per Box)

MI304-25 3" Blue Zirconia Disc - 50 Grit (25 Per Box)

Green Zirconia Discs

MI305-50 2" Green Zirconia Disc - 24 Grit (50 Per Box)

MI306-50 2" Green Zirconia Disc - 36 Grit (50 Per Box)

MI307-50 2" Green Zirconia Disc - 50 Grit (50 Per Box)



MI308-25 3" Green Zirconia Disc - 24 Grit (25 Per Box)

MI309-50 3" Green Zirconia Disc - 36 Grit (25 Per Box)

MI310-25 3" Green Zirconia Disc - 50 Grit (25 Per Box)

Green Cubitron Disc

MI430-25 2" Green Cubitron Disc - 36 Grit (25 Per Box)

MI431-25 2" Green Cubitron Disc - 50 Grit (25 Per Box)

MI432-25 2" Green Cubitron Disc - 80 Grit (25 Per Box)



MI435-25 3" Green Cubitron Disc - 36 Grit (25 Per Box)

MI436-25 3" Green Cubitron Disc - 50 Grit (25 Per Box)

MI437-25 3" Green Cubitron Disc - 80 Grit (25 Per Box)

Red Ceramic Discs

MI402-25 2" Red Ceramic Disc - 36 Grit (25 Per Box)

MI403-25 2" Red Ceramic Disc - 40 Grit (25 Per Box)

MI404-25 2" Red Ceramic Disc - 50 Grit (25 Per Box)

MI405-25 2" Red Ceramic Disc - 60 Grit (25 Per Box)

MI406-25 2" Red Ceramic Disc - 80 Grit (25 Per Box)



MI412-25 3" Red Ceramic Disc - 36 Grit (25 Per Box)

MI413-25 3" Red Ceramic Disc - 40 Grit (25 Per Box)

MI414-25 3" Red Ceramic Disc - 50 Grit (25 Per Box)

MI417-25 3" Red Ceramic Disc - 60 Grit (25 Per Box)

MI416-25 3" Red Ceramic Disc - 80 Grit (25 Per Box)

Arbors

MI20 3" Arbor Roloc Type Holder

MI200 2" Arbor Roloc Type Holder



ABRASIVES

Clamshell Packed Abrasives

- CW1CLAM** Cut Off Wheel 3" x 1/16" x 3/8" (10 Pack)
- MI17CLAM** 3" Surface Conditioning Disc Coarse Grit (Brown) (10 Pack)
- MI197CLAM** 2" Surface Conditioning Disc Coarse Grit (Brown) (10 Pack)
- CW19-10** **Platinum Sure Life Cut-Off Wheel (10 Pack)**
3" x 1/16" x 3/8" Hole, 3M # 31990
Made Of Cubic Zirconium (Out Last 3M Green Corps)
- CW29-10** **Platinum Sure Life Cut-Off Wheel (10 Pack)**
3" x 1/32" x 3/8" Hole 3M # 31989
Made Of Cubic Zirconium (Out Last 3M Green Corps)



Cut Off Wheels

- CW1-50** Cut Off Wheel 3" x 1/16" x 3/8" (50 Per Box)
- CW5-50** Cut Off Wheel 3" x 1/32" x 3/8" (50 Per Box)
- CW10-50** Cut Off Wheel 3" x 3/32" x 3/8" (50 Per Box)
- CW15-50** Cut Off Wheel 4" x 1/32" x 3/8" (50 Per Box)



Hand Pads - Scuff Pads

- MI8040-20** Ultra Fine White Hand Pad 6" x 9" (20 Per Box)
- MI8047-10** Medium Maroon Hand Pad 6" x 9" (10 Per Box)
- MI8048-20** Fine Gray Hand Pad 6" x 9" (20 Per Box)
- MI8049-20** Coarse Green Hand Pad 6" x 9" (20 Per Box)



Flap Wheels

- MI501** Flap Wheel 1" x 1" x 1/4" - 40 Grit (Each)
- MI502** Flap Wheel 1" x 1" x 1/4" - 60 Grit (Each)
- MI503** Flap Wheel 1" x 1" x 1/4" - 80 Grit (Each)
- MI504** Flap Wheel 1" x 1" x 1/4" - 120 Grit (Each)
- MI505** Flap Wheel 1" x 1" x 1/4" - 180 Grit (Each)
- MI506** Flap Wheel 1.5" x 1" x 1/4" - 40 Grit (Each)
- MI507** Flap Wheel 1.5" x 1" x 1/4" - 60 Grit (Each)
- MI508** Flap Wheel 1.5" x 1" x 1/4" - 80 Grit (Each)
- MI509** Flap Wheel 1.5" x 1" x 1/4" - 120 Grit (Each)
- MI510** Flap Wheel 1.5" x 1" x 1/4" - 180 Grit (Each)



- MI511** Flap Wheel 2" x 1" x 1/4" - 40 Grit (Each)
- MI512** Flap Wheel 2" x 1" x 1/4" - 60 Grit (Each)
- MI513** Flap Wheel 2" x 1" x 1/4" - 80 Grit (Each)
- MI514** Flap Wheel 2" x 1" x 1/4" - 120 Grit (Each)
- MI515** Flap Wheel 2" x 1" x 1/4" - 180 Grit (Each)
- MI516** Flap Wheel 3" x 1" x 1/4" - 40 Grit (Each)
- MI517** Flap Wheel 3" x 1" x 1/4" - 60 Grit (Each)
- MI518** Flap Wheel 3" x 1" x 1/4" - 80 Grit (Each)
- MI519** Flap Wheel 3" x 1" x 1/4" - 120 Grit (Each)
- MI520** Flap Wheel 3" x 1" x 1/4" - 180 Grit (Each)

Shop Rolls

- MI5002** 320 Grit Aluminum Oxide 1" x 50 Yards
- MI5004** 240 Grit Aluminum Oxide 1" x 50 Yards (Roll)
- MI5006** 180 Grit Aluminum Oxide 1" x 50 Yards (Roll)
- MI5026** 180 Grit Aluminum Oxide 1 1/2" x 50 Yards (Roll)
- MI5028** 120 Grit Aluminum Oxide 1 1/2" x 50 Yards (Roll)
- MI5102** 400 Grit Aluminum Oxide 1" x 50 Yards (Roll)
- MI5109** 120 Grit Aluminum Oxide 1" x 50 Yards (Roll)
- MI5111** 80 Grit Aluminum Oxide 1" x 50 Yards (Roll)
- MI5112** 60 Grit Aluminum Oxide 1" x 50 Yards (Roll)
- MI5116** 400 Grit Aluminum Oxide 1 1/2" x 50 Yards (Roll)
- MI5117** 320 Grit Aluminum Oxide 1 1/2" x 50 Yards (Roll)
- MI5119** 240 Grit Aluminum Oxide 1 1/2" x 50 Yards (Roll)
- MI5125** 80 Grit Aluminum Oxide 1 1/2" x 50 Yards (Roll)



Strip Away Discs

- MI577-25** 2" Stripping Disc (Quick Change Type) (25 / Box)
- MI579-25** 3" Stripping Disc (Quick Change Type) (25 / Box)
- MI580** 3" x 1/2" x 1/4" Arbor Hole Plain Strip Away
- MI581** 4" x 1/2" x 1/4" Arbor Hole Plain Strip Away





7135 16th Street East Suite 124 * Sarasota, Florida 34243
800-888-7751 * 888-351-3987 Fax
www.themainresource.com * sales@themainresource.com